

- Be sure to read this instruction manual before using the product.

NO.1

Instruction Manual for Elephant β Small Electric Chain Hoists (β S and β H types)

- Thank you for purchasing this Elephant product.
- Before using this electric chain hoist, read this instruction manual carefully to ensure that you use the chain hoist correctly.
- This instruction manual is necessary for carrying out maintenance or inspection of the product, so store it carefully.
- Please contact your local Elephant dealer or our sales office regarding the inspection items that necessitate disassembly and re-assembly.



ELEPHANT CHAIN BLOCK CO.,LTD.

Osaka JAPAN

I) SAFETY PRECAUTIONS



If you use this electric chain hoist incorrectly, a dangerous situation, such as falling of a suspending load, or an electric shock, may arise. Before installing, operating, maintaining or inspecting the chain hoist, be sure to read this instruction manual carefully so that you use the chain hoist correctly.

It is very important that not only the employer but also the operators of the chain hoist are familiar with "Safety rules" in your country.

"Procedure for slinging work" and "Working rules" of your company, etc. and that only persons who are authorized as fully trained operators of the chain hoist shall engage in the chain hoisting work. This manual is written on the assumption that only such persons as mentioned above will operate the unit.



Before using this equipment, ensure that you have a thorough knowledge of all safety information and precautions.

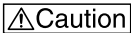

In this instruction manual, precautions are classified under "Warning" and "Caution."



 WARNING	Indicates a situation in which a dangerous condition can conceivably arise if the product is used incorrectly, resulting in the possibility of death or serious injury.
 CAUTION	Indicates a situation in which a dangerous condition can conceivably arise if the product is used incorrectly, resulting in the possibility of moderate or light injury, or physical damage alone.

Even if an item is classified under  Caution, there is a possibility of a serious result occurring depending upon the particular situation. All such items indicate important contents, so please observe them.

Examples of pictorial indications



 The symbol  or  indicates that the contents of the items following the symbol are dangerous and necessitate care. The concrete precautions or warnings to be heeded are shown inside these symbols. (The symbol at left is a warning against electric shock.)

 The symbol  indicates prohibited behavior. The concrete type of behavior that is prohibited is indicated inside or near the symbol.

 The symbol  indicates action to be enforced or action concerning which instructions are to be issued. The concrete instructions are indicated inside or near the symbol. (The symbol at left indicates that the point concerned must always be grounded.)





※After reading this instruction manual, be sure to store it in a readily accessible location.

1. Items concerning the handling of the product



 WARNING	
<ul style="list-style-type: none"> ● This product must not be operated by a person who is not thoroughly familiar with the contents of this instruction manual or the caution labels.  ● A person who does not have the legally mandated qualifications must never carry out a crane operation or slinging work, or cause another person to carry out this work. 	

- Be sure to carry out a pre-work inspection and also periodic voluntary inspections. 

2. Items concerning installation

 WARNING	
<ul style="list-style-type: none"> ● The product must only be installed by specialist contractors or persons with specialized knowledge.  ● Do not install the electric chain hoist in an unspecified environment, such as in a place where it is likely to be exposed to rain or water. 	
<ul style="list-style-type: none"> ● Be sure to ground the electric chain hoist. Also, install a ground fault circuit interrupter in the power supply circuit.  	
<ul style="list-style-type: none"> ● When using the product as a simple lift, be sure to observe the relevant regulations. ● Be sure to install stoppers on the ends of the traverse and travel rails. ● Confirm that the surface on which the electric chain hoist is to be installed has adequate strength to support it. ● Suspend the electric chain hoist in such a way that it can swing freely. ● Be sure to install the chain bucket before installing the electric chain hoist. 	

3. Items concerning operation

 WARNING	
<ul style="list-style-type: none"> ● Never suspend a load that exceeds the rated load.  <ul style="list-style-type: none"> ※The rated load is indicated on the nameplate of the hook block. ● Do not allow a person to stand on a suspended load. Also, never use the electric chain hoist for an application that requires a person to stand on it. ● Do not stand beneath a suspended load. ● Do not operate the electric chain hoist while a person is inside the range of motion of the suspended load. ● Do not move a suspended load over a person's head. ● Do not move away from the operation position while a load is suspended. ● Do not allow your attention to wander from the load while operating the electric chain hoist. ● Do not operate the chain block in a way that causes the load or the hook block to swing. ● Do not continuously operate the upper and lower limit slip mechanisms in order to stop the electric chain hoist. ● Do not pull a load obliquely. <ul style="list-style-type: none"> ※Before hoisting a load, move the electric chain hoist to a position that is directly above the load. ● Do not hoist a load while either it or the sling is attached to another load or a structural member. 	

- Do not attempt to invert a suspended load.
 - ※ Use dedicated inversion equipment to invert a load.
- Before using the electric chain hoist, check the operation of the pushbuttons. Do not operate the electric chain hoist if a pushbutton does not operate smoothly.
- If the electric chain hoist moves in a different direction from that indicated on the pushbutton that was pressed, immediately stop operation.
- Before using the electric chain hoist, check the operation of the brake. If the brake does not function reliably, do not operate the electric chain hoist.
- Do not operate the electric chain hoist if it is damaged, or if it generates abnormal noise or vibration.
- Never operate the electric chain hoist if the load chain has one of the following abnormalities.
 - ※ One that is twisted or entangled, one that is cracked or damaged, or one that is not correctly engaged
 - ※ One that has stretched past the specified length, one that is very worn
- Do not carry out electric welding on a suspended load.
- Do not connect the ground terminal of a welding machine to the load chain.
- Never bring a welding electrode into contact with the load chain.
- When carrying out welding work out on the building, take steps to ensure that the electric chain hoist does not form part of the grounding circuit of the welding machine.
 - ※ The welding current will cause the wiring inside the electric chain hoist to burn out.

 **CAUTION**

- Do not use the electric chain hoist at a voltage other than the rated voltage.
- Never use the electric chain hoist if the safety latch is broken.
- Do not pluck (rapidly reverse) the electric chain hoist or inch it to an excessive degree.
- Do not attach the suspended load to another structure or an electrical cable.
- Do not attach the cord of the pushbutton switch unit to another object, or pull on the cord using a large force.
- Do not cause the main unit or the trolley to collide with the stopper or a structure.
- Do not wind the load chain directly around the load.
- Do not allow the load chain to touch sharp edges.
- Do not allow the chain bucket to be thrust up by the load or the sling.
- Never use the electric chain hoist in excess of its short-time rating, load time efficiency and starting frequency.
- Do not allow a person who has no specialized knowledge to connect the output from an engine-powered generator to the power inlet of a single phase electric chain hoist.
- Do not use the electric chain hoist if the warning or caution nameplate or label installed on it has been removed or is illegible.

- Before using the electric chain hoist, confirm that the bottom hook rotates smoothly.
- Attach the sling correctly to the hook.
- When hoisting a load, stop the electric chain hoist momentarily once the load chain is taut.
- Keep the vicinity of the pushbuttons clean to prevent the accumulation of dust, sand or dirt.
- When hoisting a load using two electric chain hoists, use an operation method in which the chain hoists are linked to each other.
- Confirm that the lifting height is adequate for the work in hand.

4. Items concerning maintenance and modification

 **WARNING**

- Never modify the product or its accessories.
- Never use parts other than our genuine parts.
- Never cut the load chain or extend its length.
- Switch off the power before carrying out maintenance and inspection or repair.
- Ensure that maintenance and inspection or repair is carried out only by persons possessing specialized knowledge designated by the contractor.
- When carrying out maintenance and inspection or repair of the electric chain hoist, ensure that it is not suspending a load.
- If you find an abnormality in the electric chain hoist during maintenance and inspection, do not use it in that condition, but repair it.

 **CAUTION**

- Before carrying out maintenance and inspection or repair, be sure to erect a WORK IN PROGRESS sign (or an INSPECTION IN PROGRESS or a DO NOT SWITCH ON sign).

Note:

- If an inspection item necessitates disassembly and re-assembly of the electric chain hoist, be sure to request your local Elephant products dealer or Elephant sales office to carry out this work.

CONTENTS

I) SAFETY PRECAUTIONS	1
1. Items concerning the handling of the product	1
2. Items concerning installation	1
3. Items concerning operation	1
4. Items concerning maintenance and modification	2
II) NAME OF EACH PART	3
III) PRODUCT CHECK, AND PRECAUTIONS FOR INSTALLATION	4
1. Product Check	4
2. Precautions for Using the Product in a Special Environment	4
IV) INSTALLATION METHOD	4
1. Electrical Wiring	4
2. How to install the Electric Chain Hoist	5
3. How to Install the Chain Bucket	6
4. When Using the Electric Chain Hoist with a Trolley	7
5. Post-installation Checks, and Trial Operation	8
V) PRECAUTIONS FOR USE	9
1. Correct Method of Use, and Precautions	9
2. Precautions for Operation	9
3. Operating Time	12
4. Other Precautions	12
VI) MAINTENANCE AND INSPECTION	13
1. Overall maintenance	13
VII) DAILY INSPECTION	13
1. Pre-operation Checks	13
2. No-load Operation Check	14
3. Rated Load Operation Check	14
VIII) PERIODIC VOLUNTARY INSPECTIONS	14
1. Monthly Voluntary Inspection	14
2. Yearly Voluntary Inspection	15
3. Usable Limit of Parts	15
IX) METHOD OF MAINTENANCE AND INSPECTION	15
1. Before Carrying Out an Inspection	15
2. Hook Inspection and Usable Limit	15
3. Chain Inspection and Usable Limit	16
4. Buffer Inspection and Usable Limit	17
5. Chain Bucket Inspection and Usable Limit	17
6. Chain Stopper Inspection	17
7. Pushbutton Switch Inspection	17
8. Trolley Inspection and Usable Limit	17
9. Motor Brush Inspection and Usable Limit	17
10. Nameplate and Tag Inspection	17
11. Gear Oil Inspection	18
12. Wiring the Inside of the Electric Chain Hoist and Tightening the Various Parts	18
13. Overall Operation Check and Usable Limit	18
X) TROUBLESHOOTING AND REMEDY	18
XI) STANDARDS COVERING USE AND INSPECTION (JIS)	20
XII) WIRING DIAGRAM	23
DISASSEMBLY DRAWING	24

II) NAME OF EACH PART

Fig. 1 Name of each part of a β type electric chain hoist

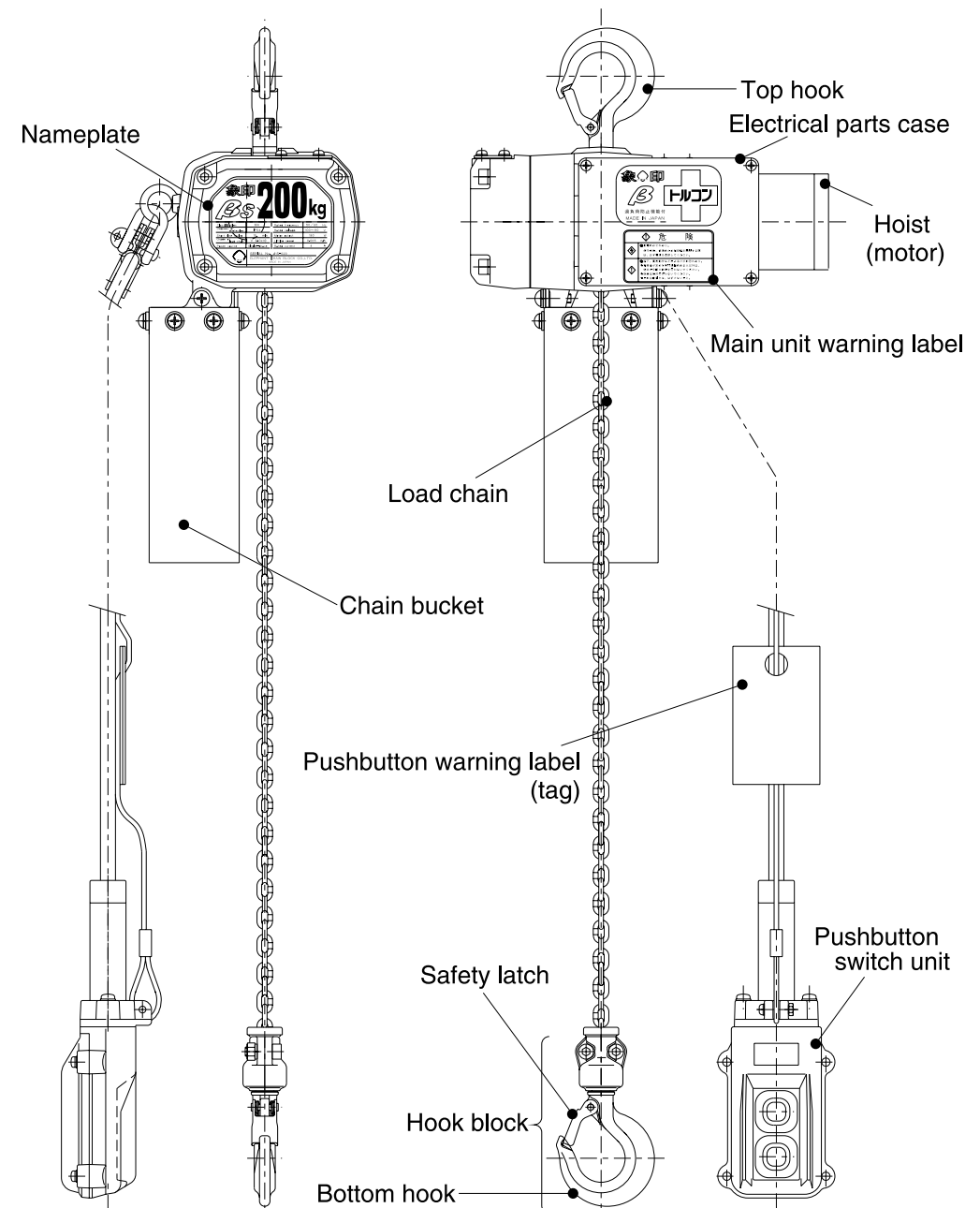

III PRODUCT CHECK AND PRECAUTIONS FOR INSTALLATION

1. Product Check

- Check to see if the electric chain hoist is the one that you ordered.
Check to see if the following items indicated on the case are as you specified.
- 1-1. Electric chain hoist (when purchased as an individual unit)**
- 1) Model Model check (Check nameplate as well.)
 - 2) Power source voltage 100 V or 200 V single phase
 - 3) Rated load Checking the rated load
 - 4) Lifting height 3m or 6m, for example (or a special lifting height)
 - 5) Type of pushbutton unit 2-button type (or 4-button type, etc.)
 - 6) Length of cord of pushbutton unit 3m or 6m, for example (or special lifting height)
 - 7) Power cord length 3m
- 1-2. Trolley (when you purchased the electric chain hoist with a trolley)**
- 1) Type of trolley Plain trolley, geared trolley, etc.
 - 2) Rated load Checking the rated load
※If you specified a special lifting height or a special cord length, check the lifting height or the cord length.
- Check to see if there is any damage that appears to have been caused in transit, or any other damage.
 - Check to see if the specified accessories and documents have been provided.

List of accessories and documents	
Instruction manual	(1)copy
Trolley instruction manual (If you ordered the electric chain hoist with a trolley)	(1)copy
Electric chain hoist inspection certificate	(1)copy
Chain gauge	(1)
Chain bucket	(1)set

If you find any problem with the above, promptly inform your local dealer or our sales office.

2. Precautions for Using the Product in a Special Environment

WARNING

- The product cannot be used in an environment containing an explosive substance.
※A place where there is an organic solvent or explosive dust.
- When it is necessary to use the product in a special atmosphere such as in place where the temperature is high (more than 40°C), low (-10°C or below), and/or very humid (more than 90%), in a place where there is a lot of acid or alkali, or in a place where it the product is likely to be affected by chemicals, be sure to contact our sales office.

- When it is necessary to use the product outdoors, be sure to provide an evacuation place or a cover in order to protect the body of the unit from wind and rain, or snow.
※If the temperature is particularly low, the metal of the product will become brittle, so it is necessary to allow adequate margin of capacity.

IV) INSTALLATION METHOD

WARNING

- You cannot use a β type electric chain hoist as an elevator.
- Be sure to ground the electric chain hoist.
※This is necessary for preventing the possibility of electric shock due to leakage current.
- Ensure that the place where the electric chain hoist is to be installed has adequate strength.
※This is to prevent the electric chain hoist from falling, resulting in possible injury.



1. Electrical Wiring (Refer to the wiring diagram on P23.)

Request a specialist contractor to carry out electrical work, and ensure that the work is carried out correctly according to this instruction manual. Have electrical work carried out according to the electrical equipment engineering standard and the indoor wiring regulations.

- Before connecting the power source to the electric chain hoist, confirm that the power source voltage matches the applicable power source voltage for the product.
- 1-1. How to wire the product to a single phase power source**
- In the case of a 100 V single phase power source, install a plug with a ground pin or lead on the power cable.
When using a 200 V power source, a plug is not installed, so request an electrical contractor to carry out appropriate wiring work.
 - Be sure to connect a ground lead.
※Check to see if the current carrying capacity of the wall outlet is adequate.
 - When you wish to connect a single phase power source from an engine-driven generator, use a generator that has a rated output of at least 1 kVA. You cannot use a generator that has a slow-down function or a generator intended for welding use. Also, be sure to connect a grounding lead.

1-2. Setting the power cable (power cord)

CAUTION

- Do not use an excessively thin power cable or a power source that outputs reduced voltage. 
- ※This is because the electric chain hoist may fail to function normally, or the cable may overheat.

If the resistance (Unit: Ω) of the cable between the power source and the electric chain hoist and also that of other electricity supply equipment is large, the voltage (Unit: V) supplied to the electric chain hoist will fall markedly. As a result, the electric chain hoist may fail to function normally, or the power cable may overheat or burn out.

- When extending the length of the power cable, ensure that the total length is no more than the following.

Thickness of the extension cable

2mm² To 50 m (for 100 V), or to 100 m (for 200 V)

1.25mm² To 30 m (for 100 V), or to 60 m (for 200 V)

※If you specified a special lifting height or a special cord length, check the lifting height or the cord length.

- Check to see if there is any damage that appears to have been caused in transit, or any other damage.
- Check to see if the specified accessories and documents have been provided.

Fig. 2 Powerful!

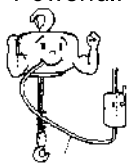

A thick (small resistance value per m) and short power cable ensures good performance.

Fig. 3

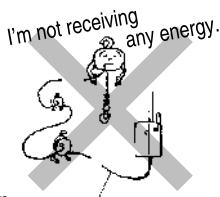

A thin (large resistance value per m) and long power cable results in poor performance.

Table 1

Power source voltage	Rated current
100 V single phase	4A
200 V single phase	2A

2. How to install the Electric Chain Hoist

WARNING

- Carry out installation work in a place where there is no danger of the electric chain hoist falling. 
- Suspend the electric chain hoist in such a way that it swings freely.
 - ※This is because an unreasonable force will be applied to the fixing part, or the equipment may become damaged, causing the body of the unit to fall and injure somebody.

When using the electric chain hoist for hoisting and lowering a load, select the construction and the material of the ring to which the hook is to be attached so as to provide a safety factor of at least 5 when the rated load is suspended.

2-1. Precautions to observe prior to use

Before switching on the power, acquire an understanding of the following points to ensure that you handle the electric chain hoist correctly.

If you use the chain hoist incorrectly, the torque generated by the powerful motor may cause the load chain or another part to break.

Do not switch on the power and operate the electric chain hoist unless the situation matches that shown in this figure.

Fig. 4

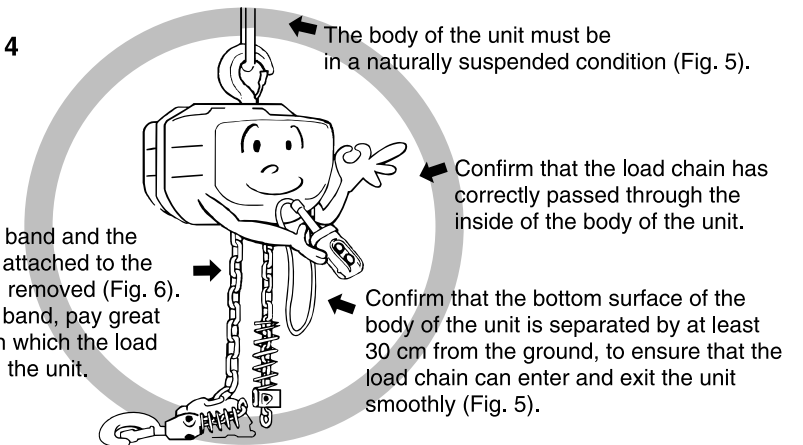

WARNING

Never operate the electric chain hoist when the body of the unit is not suspended or when it is tilted to an excessive degree. 

Fig. 5



Be sure to remove the vinyl band and the caution tag before operating the chain hoist.  If you operate the chain hoist without removing these items, the motion of the load chain will be abnormal, resulting in possible damage to parts.

Fig. 6

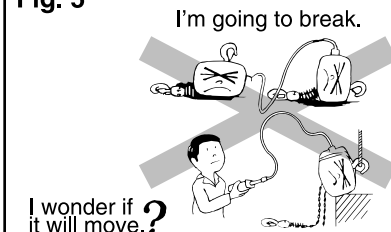

2-2. Using the chain hoist as a hook suspension type

WARNING (1. Installation method)

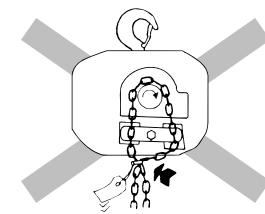

- (1) The hook attachment ring to which the top hook of the electric chain hoist is to be attached must have sufficient strength to enable it to withstand a load of at least 5 times the rated load. 
 - (2) The cross-sectional shape of the hook attachment ring must be adequately rounded and free of sharp angles. Also, apply grease or another lubricant to the contact faces of the hook and the ring.
 - (3) Upon completion of installation of the β type electric chain hoist, ensure that the safety latch of the top hook is completely closed. (Refer to Fig. 7.) 
- ※If the hook attachment ring has insufficient strength or is worn, it is liable to break, causing the suspended load and the chain hoist to drop.

Fig. 7



Check the safety latch, and ensure that it is not broken.

2-3. Using the chain hoist as a trolley coupled type

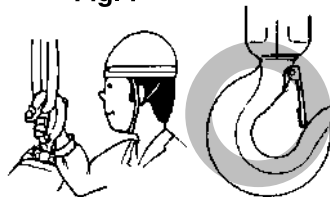
The only method that can be used to couple the β type electric chain hoist to a trolley consists of attaching the top hook of the electric chain hoist to the coupling piece (Fig. 8) of a geared trolley or a plain trolley that has been installed on a steel I-beam.

(Other coupling methods cannot be used.)

- (1) When using the electric chain hoist attached to a geared trolley of between 125 kg and 200 kg, ensure that the motor side of the body of the unit is opposite the chain wheel side of the trolley, as shown in Fig. 8.
- (2) When using the electric chain hoist attached to a plain trolley of between 125 kg and 200 kg, you can install the chain bucket on either side without problem.
- (3) Check to see if the safety latch on the top hook is completely closed.

Fig. 8 For a geared trolley of 125 kg to 200 kg

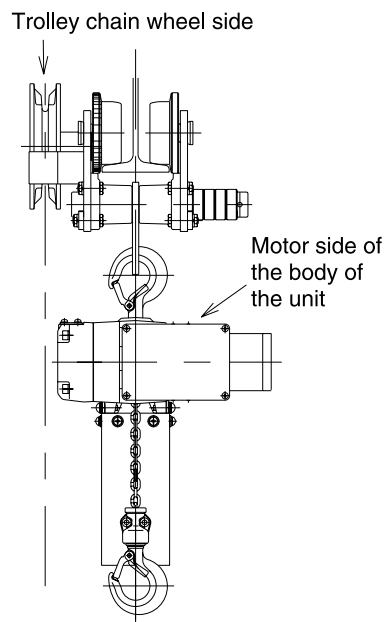

3. How to Install the Chain Bucket

3-1. How to install the chain bucket

WARNING

- Before installing the electric chain hoist, be sure to install the chain bucket.
 - ※Unless the chain bucket is installed, the chain on the no-load side may be pulled by the suspended load, for example, which is very dangerous.
 - ※It is very dangerous if the chain bucket drops from a high point while in use, so check to see if it is installed correctly.

Fig. 9

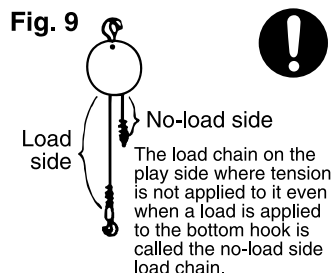

When installing the chain bucket, lower the load chain on the no-load side so that the remainder is about 10 cm. This will not only facilitate installation but also ensure that the load chain enters the chain bucket in a satisfactory condition.

Install the two mounting bolts at the top of the bucket, and then carry out a hoisting operation so that the load chain on the no-load side enters the chain bucket.

(Fig. 10)

Fig. 10

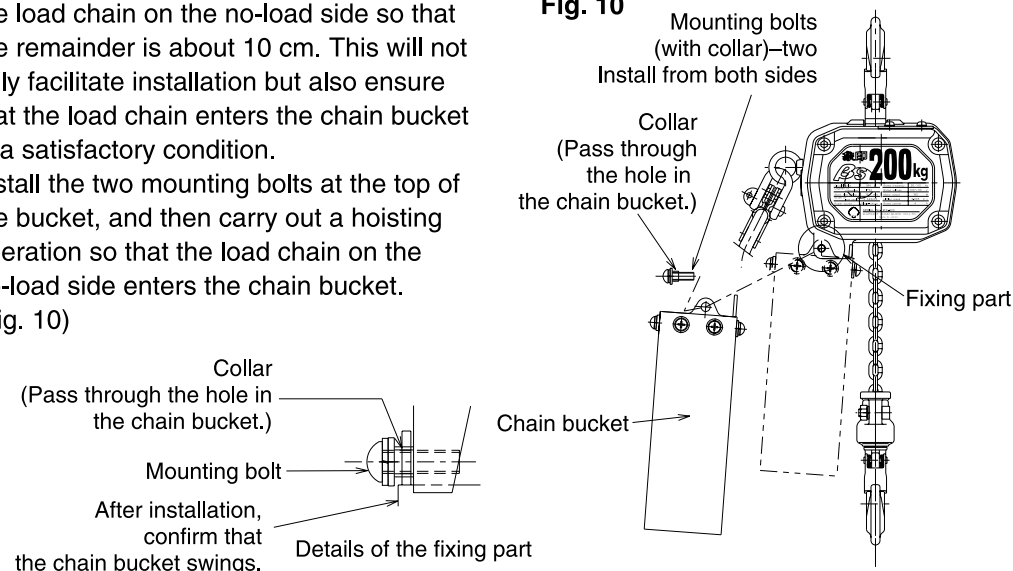

CAUTION

- Do not push up the chain bucket with the suspended load, for example. 
- Do not use a chain bucket other than one that has a length matching that of the load chain.
- Do not insert the entire load chain at once into the chain bucket.

- Maintain the chain bucket suspended naturally from the body of the electric chain hoist.
- If the chain bucket is pushed up by the suspended load, for example (Fig. 12), the load chain may spill over, or may fail to pass smoothly through the inside of the body of the chain hoist. This is dangerous!

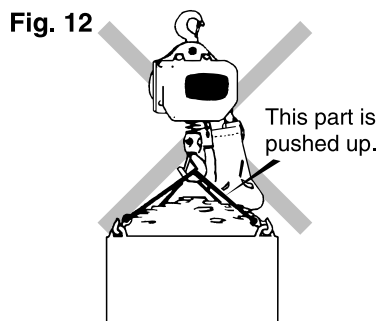
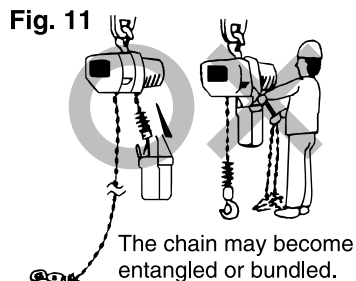

Note:

When using the chain hoist in a very dusty location, in a place where foreign matter is liable to enter the bucket, or when the chain is rusty, the chain may sometimes spill over. Keep the bucket and the chain clean, and always apply oil to the chain.

4. When Using the Electric Chain Hoist with a Trolley

4-1. Method of adjusting a geared trolley or a plain trolley to match the rail of a steel I-beam

- Method of adjusting a geared trolley for a rated load of between 125 kg and 200 kg
- Method of adjusting a plain trolley for a rated load of between 125 kg and 200 kg

1) Method of adjusting to match the width of the rail of a steel I-beam

- (1) Each trolley is shipped after having been adjusted to the minimum width of the rail of the steel I-beam that shown in table 2. For this reason, when you wish to adjust it to a rail width other than this, carry out the following procedure.
- (2) First, remove the split pin (A) shown in Fig. 13.
 - ※ **This pin is to be reused after setting work, so do not cut it or lose it.**
- (3) Remove the adjustment collars (C) from the suspension shaft.
 - ※ **The adjustment collars are to be re-assembled later, so do not lose them.**
- (4) Slacken and then remove the hex nuts (B) from the key plate.
- (5) Using Table 2, obtain the width of the rail of the steel I-beam to which the trolley is to be adjusted, and then insert the number of adjustment collars (C) corresponding to this width on both outer sides of the coupling piece, as shown in Fig. 14.

Table 2 Number of adjustment collars to be inserted into both outer sides of the coupling piece Unit: Collar

Steel I-beam rail width	50mm	75mm		100mm		125mm	
		one side	other side	one side	other side	one side	other side
Geared trolley	Unusable	0		1	1	2	2
				2		4	
Plain trolley	0	1	1	2	2	3	3
		2		4		6	



WARNING

If you mistakenly insert the adjustment collars unevenly, or if you fail to re-tighten the hex nuts sufficiently, the trolley is likely to drop off the rail.

You can adjust the trolley width over a wide range of 25 mm by using two adjustment collars. In this case, insert one collar into each side.



Fig. 13

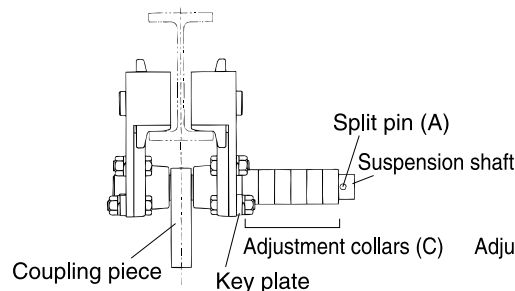
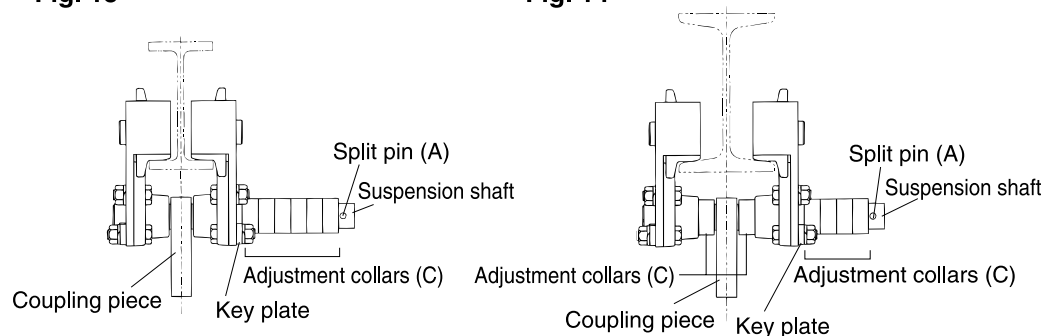

Fig. 14



- (6) Check to see if the clearance from the wheel is appropriate for the steel I-beam rail width that you intend to use.
- (7) Insert the side plate on one side, and then tighten it using the hex nuts.
- (8) Insert the remaining adjustment collars into the suspension shaft, and then set the split pin.
- (9) Use the β type electric chain hoist with the top hook attached to the coupling piece of the trolley.

4-2. Installing the trolley on a curved traverse rail

When installing an electric chain hoist with a geared trolley on a curved traverse rail, ensure that the hand chain wheel side is on the outer side of the curve.

If you install the chain hoist facing the reverse direction, the traverse rail or the gear of the trolley wheel may become damaged.

If there are curves in both the “right” and “left” directions on the traverse rail, install the trolley on the curve that has the smaller radius, as shown in the figure.(Fig. 15)

4-3. Traverse rail and stopper



WARNING

- To prevent the possibility of the chain hoist or the trolley dropping off, be sure to install a stopper at the end of the rail.
- Do not stop the trolley by causing it to collide with the stopper.

Do not paint the part of the traverse rail that strikes the wheel of the trolley. If it is very rusty, remove the rust.

● Concerning the joints of the traverse rail

- 1) Set the joints near the supports of the traverse rail.
- 2) When welding a reinforcing plate (Fig. 16) to the side face or bottom face, be careful of the thickness of the reinforcing plate.

If you use a thick reinforcing plate, the trolley may strike it, preventing the trolley from passing over the joint.

- 3) Carefully align adjacent rail sections so that the mismatch in both the left-right and vertical directions is no more than 0.5 mm, then using a grinder finish off the part of the rail joint over which the trolley wheel passes. (Fig. 17)

● Concerning the drop-off prevention stopper at the end of the rail

- 1) Ensure that the clearance (a) shown in Fig. 18 is large enough to prevent the trolley type electric chain hoist from striking the wall or another part of the room in the event that it stops abruptly and shakes.
- 2) Install the electric chain hoist securely so that it withstands impact, and be sure to install cushioning material, such as rubber. (Table 3 and Fig. 19)

- Never install the trolley type electric chain hoist in such a way that the trolley always collides with the stopper and stops.

Fig. 15

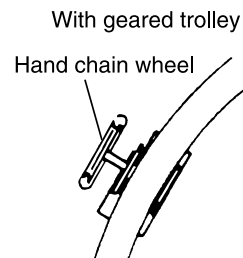

Fig. 16

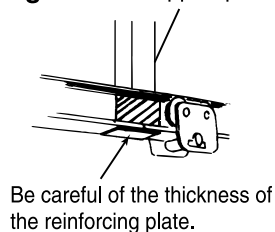

Fig. 17

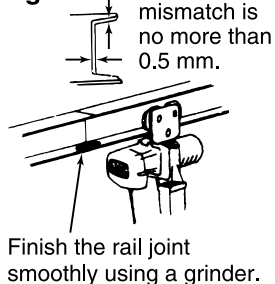

Fig. 18

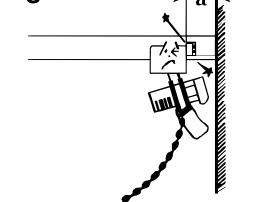
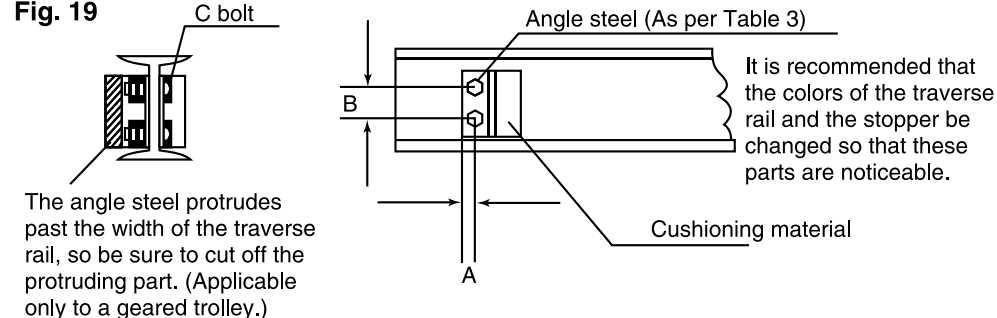

Table 3 Stopper

Traverse rail dimensions (mm)	150×75	200×100	250×125
Angle steel (mm)	L50×50×6		L65×65×6
A (mm)	20		30
B (mm)	50		
C (mm)	M12		

Fig. 19



5. Post-installation Checks, and Trial Operation

After installing the electric chain hoist, check the following items.

- 1) Pre-operation check
- 2) No-load operation check
- 3) Rated load operation check

- Carry out checks and trial operation according to “Daily inspection” (Page 13).



WARNING

- Never use the electric chain hoist when the load chain is bundled, entangled or knotted.
- The chain of some models is bound with wire to prevent it from becoming entangled while the product is being transported (in a packed condition). In this case, completely remove the wire before using the product.
 - ※ Ensure that cut pieces of wire, pieces of vinyl, or the caution tag, do not become lodged in the electric chain hoist.
- Do not operate the electric chain hoist in such a way as to cause the upper and lower over-winding prevention devices to trip all the time.
 - ※ The over-winding prevention devices are intended to be used only in an emergency, not for normal use.

Fig. 20

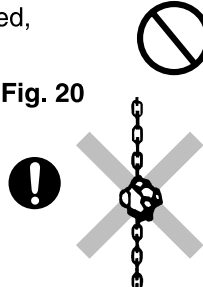

- After installing the electric chain hoist, measure and record the dimension of the opening in the bottom hook and also the dimension of the part to which the wire rope is attached.
 - ※ This is necessary for comparing the size of the opening and also the amount of wear when inspecting the bottom hook.

V) PRECAUTIONS FOR USE

WARNING

- This electric chain hoist must not be operated by a person who does not have adequate knowledge of the contents of the instruction manual or the caution nameplate. 
- A person who is not skilled in the use of a chain hoist must never carry out a crane operation or slinging work, or have another worker carry out such work.

1. Correct Method of Use, and Precautions

1-1. Slings

CAUTION

- Before starting work, inspect all of the slings to be used that day. 
- Use the safest sling (hoisting accessory) that is appropriate for the shape of the load.
 - ※ Safety factor of slinging chain: 5 or more, Safety factor of slinging wire rope: 6 or more, Safety factor of slinging belt sling: 6 or more

1-2. Safe slinging method

Carry out slinging work carefully, using a sling that is of an appropriate performance and length. It goes without saying that you must pay attention to the load applied to the sling. Also, check to ensure that there are no problems such as those shown in Fig. 21, Fig. 22 and Fig. 23.

● Example of incorrect use (1)

If you hoist a load while the sling is not in an appropriate position on the hook, the sling may slip out of place, causing a shock to be applied to the load, which is very dangerous. In this case, lower the load, and then re-suspend the sling correctly.

● Example of incorrect use (2)

If the angle θ shown in the figure is too wide, the force applied to the sling will increase, which may cause the safety latch to break or the load to drop off.

In this case, change the load suspension position. Alternatively, if there is sufficient margin of hoisting distance, you can obtain better performance by changing over the sling for a longer one. Ensure that the angle θ shown in the figure is within 60° .

Fig. 21 Example of incorrect use (1)



Example in which the sling is attached near the end of the hook

Fig. 22 Example of incorrect use (2)



Example of the case in which the angle is too wide

Fig. 23 Example of incorrect use (3)

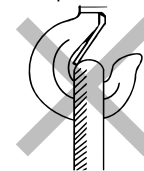

Example in which the sling is too thick

● Example of incorrect use (3)

The sling is thick, preventing the safety latch from returning to the normal position. Change the sling. Consider the use of a chain sling with attachments.

{ Please make inquiries to your local dealer or our sales department.
We have available various kinds of slings for optimum work efficiency. }

CAUTION

- Never wind the load chain directly around the suspended load, regardless of whether the load is heavy or light, because this is very dangerous. (Fig. 24)
- Never use the electric chain hoist when the safety latch on the hook is broken.
 - ※ Constantly maintain the safety latch to ensure that it functions normally, and check to see if it operates correctly. (Fig. 25)

Fig. 24

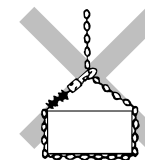
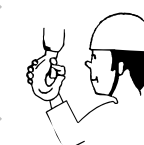

Fig. 25



1-3. When starting to hoist the load

When slinging is completed and the load is about to be hoisted

- When the load chain of the chain hoist and also the sling are quite taut, first check the slinging condition.
- Next, raise the load by a very small amount, and check to see if the load balance is satisfactory.
- Next, raise and lower the load a number of times by several tens of cm, and confirm that the brake of the electric chain hoist functions correctly.

Be sure to acquire the habit of checking the above three points before raising the load to any significant degree. (Fig. 26)

Fig. 26

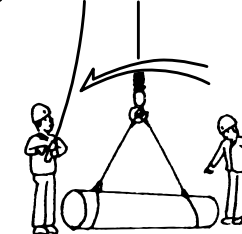

2) Balance OK 1) Slinging OK
3) Brake OK

2. Precautions for Operation

2-1. Raising and lowering the load

WARNING

- Never suspend a load that exceeds the rated value.
 - ※ The electric chain hoist may become damaged, or the load may drop, which is very dangerous. 

- Do not suspend the β type electric chain hoist beneath a large capacity hoisting machine, such as a crane, and use it to lower a load.
 - ※ If you raise a large load that exceeds the rating of the β type electric chain hoist using the above-mentioned large capacity crane, or the like, the β type electric chain hoist will break, and both it and the load will drop, resulting in an accident.
- Never hoist a load while either it or the sling is attached to a structural member.
 - ※ This will result in an unreasonable force being applied to the chain hoist, causing it to break.
- Do not raise or lower the load to an excessive degree.
 - ※ The over-winding prevention devices that prevent a load from being over-hoisted or over-lowered are of a slip construction. If you frequently over-hoist or over-lower the load, a very large load will be applied to the body of the electric chain hoist and the load chain, leading to possible breakage. If you over-hoisted or over-lowered a load, promptly remove your finger from the pushbutton switch. Do not continue to press the switch for three seconds or longer while the chain hoist is in a slipped condition, because wear or jam of the brake lining is likely to occur.
- Do not move or add a chain stopper in order to stop the over-winding prevention device in a certain position.
- Do not operate the over-winding prevention devices other than when inspecting them.
 - ※ When carrying out an inspection, do not check the over-hoisting and over-lowering operations by abruptly raising and lowering the chain hoist. Stop the chain hoist momentarily before the limit, and then check the over-hoisting operation, and also the over-lowering operation, over a short distance. If it is necessary to adjust the over-winding prevention devices, please contact our service department.

CAUTION

- When hoisting or lower a load, do not allow it to swing.
- When there is no load, do not allow the electric chain hoist to swing.
 - ※ The load may drop, or the chain may become damaged.
- Do not pull the load obliquely (pull it vertically or horizontally). Be sure to move the electric chain hoist to a point immediately above the load, and then hoist the load.
 - ※ It is very dangerous to pull the load obliquely because while the load is being dragged along the ground it is likely to abruptly move off at high speed, or a force may be applied obliquely to the support of the electric chain hoist, so do not do this. (Fig. 27 and Fig. 28)

Fig. 27



- Do not attempt to hoist a load using two electric chain hoists because this is extremely dangerous.
 - ※ If it is unavoidably necessary to hoist a load using two electric chain hoists, have this work done by persons with specialized knowledge. Also, be careful of the following points while checking for any obliqueness of the load.
 - ※ When hoisting a load using two electric chain hoists, either use a method of operation in which the chain hoists are linked to each other, or select electric chain hoists intended for 2-point horizontal suspension.
 - ※ Use both electric chain hoists at the same hoisting speed.
 - ※ Take steps to prevent the two chain hoists from colliding with each other, such as by using a collision prevention device.
- When suspending one load using two electric chain hoists, if a large angle is subtended between the load chain and a vertical line, or if the location of the center of gravity of the load is very near one of the two hoisting positions (Fig. 29), a greater load than expected will be applied to the electric chain hoist.
 - ※ In addition, various kinds of danger, such as unexpected traveling of the trolley, for example, are predicted.

Fig. 28

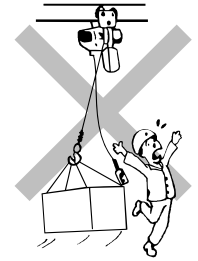
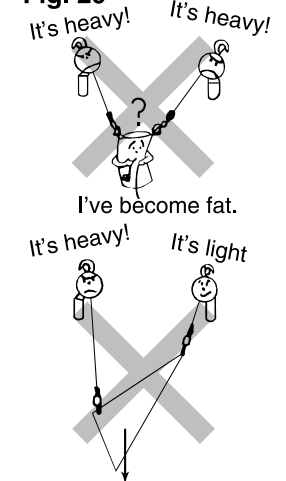

Fig. 29



- When hoisting a load, first stop the electric chain hoist when the chain becomes taut, and confirm that it is safe.
 - ※ This will enable the impact generated during dynamic liftoff to be mitigated, and also reduce damage to the chain.
- Do not thrust up the chain bucket using the load or the sling.
 - ※ This is because there is a danger of the chain spilling over, or the chain bucket becoming damaged.
- Do not invert the suspended load. If inversion work is necessary, select a dedicated electric chain hoist.
 - ※ There is a risk of an abnormally large impact being generated.
- Do not use the electric chain hoist while something is touching the body of the chain hoist, or when body of the chain hoist has been fixed.
 - ※ Be sure to use the body of the electric chain hoist when it is in a naturally suspended condition.
 - ※ The body of the chain hoist is designed to be used suspended naturally from a hook or a trolley. It swings very slightly along with the rotation of the polygonal load sheave (a part that transmits drive force to the load chain).

※Do not impede this natural swing. If the abovementioned swing is restricted, a force other than that calculated will be applied to each part, which is very dangerous. (Fig. 30)

- While a load is being lowered, resonance sometimes causes it to swing greatly. In this case, stop lowering the load, wait until it stops swinging, and then resume lowering it.
- During and after use, the motor and the body of the electric chain hoist are extremely hot, putting you at risk of receiving a burn, so be very careful.

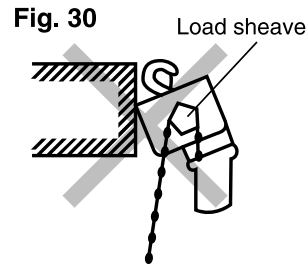

2-2. Moving a load (traversing)

⚠ CAUTION

- Ensure that nobody enters the area directly beneath the suspended load or is in the path of the load. (Fig. 31)
 - ※ There is a danger of the suspended load colliding with a person.
- Do not allow the electric chain hoist or the trolley to collide with the trolley stopper or a structure.
 - ※ This may cause the suspended load to fall.
 - ※ Be particularly careful of the traversing motion of the trolley when it is near the stopper, and ensure that the trolley stops naturally before it strikes the stopper. (Fig. 32)
- Do not move the trolley by pulling it with the cord of the pushbutton unit. (Fig. 33)
 - ※ This is because of the risk of a broken wire.
- Do not attach the hand chain of a geared trolley to a suspended load or a truck bed.
 - ※ The hand chain of the geared trolley may become caught on the suspended load or a hook on the bed of a truck, for example, and if it is pulled hard, the trolley is likely to become deformed or drop.
 - ※ Pay adequate attention to the hand chain of the geared trolley. (Fig. 34)

Fig. 31

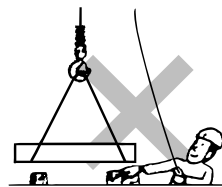

Fig. 33

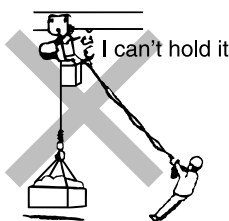

Fig. 32

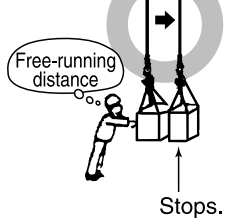
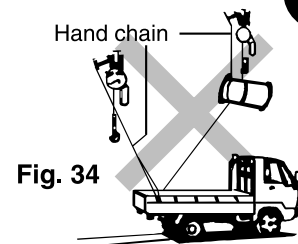

Fig. 34



2-3. Operating the pushbutton switches

- Before using the electric chain hoist, be sure to check that the pushbuttons operate smoothly.
- Push in the pushbutton firmly until you feel a response.

⚠ CAUTION

- Do not operate the electric chain hoist if it moves in the reverse direction to that indicated on the pushbutton switch.
 - ※ Contact us.
- Do not abruptly carry out a reversing operation (plugging).
 - ※ First stop the suspended load, and then perform a reversing operation.
 - ※ If you perform an abrupt reversing operation, a large instantaneous load exceeding twice the weight of the suspended load may be applied to the chain hoist. This will greatly reduce the life of the body of the chain hoist and also the load chain. Also, the magnet of the motor may deteriorate, causing the speed to change (increase).
- Push in the pushbutton firmly to the position where a response is felt, and then promptly release. Do not operate the chain hoist with the pushbutton held in a half-pressed condition.
 - ※ The life of the contacts of the pushbuttons will be reduced.

Fig. 35

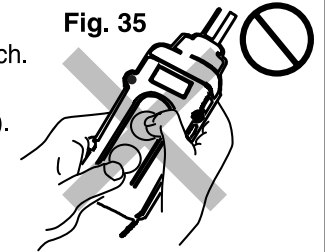

⚠ CAUTION

- Do not carry out frequent inching operations.
 - ※ An inching operation causes a tension that is greater than that applied in normal use to be generated instantaneously in the load chain.
 - ※ An inching operation causes wear of the brake and the contacts of the electrical parts, and also overheating of the motor.
- After operating the electric chain hoist, return the pushbutton switch case to the position where it hangs down naturally from the electric chain hoist, and then release it. (Fig. 36) This is to prevent unforeseen damage or a malfunction.
- The operation voltage of the pushbuttons is either 100V or 200V.
 - ※ Keep the vicinity of the pushbuttons clean to prevent the accumulation of dust and sand.
 - ※ If the event that the pushbutton switch unit is cracked, parts have dropped out of it, or foreign matter adheres to the pushbuttons, there is a risk of electric shock or a malfunction, so replace the pushbutton switch unit with a new one.
- If the reinforced plastic case of the pushbutton switch unit is exposed to a high temperature, it is liable to become deformed.

Fig. 36

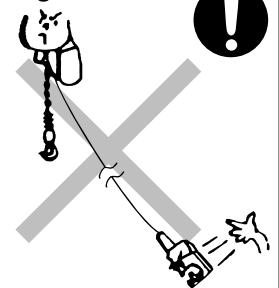

2-4. For safe work

CAUTION

- Never leave the workplace while a load suspended.
- Do not allow your attention to wander while the electric chain hoist is operating.
 - ※ It is very dangerous for anyone other than the operator to go near the load.
 - ※ The operator must not leave the operation position while a load is suspended from the electric chain hoist. (Fig. 37)
 - ※ If the load has been hoisted, the operator must continually monitor the safety of the load and its vicinity at his own responsibility.
- Never stand or work on a suspended load.
 - ※ There is a risk that the suspended load may unstable, causing the worker and/or the load to fall.
- Never transport a load over a person's head.
 - ※ The load may fall on that person, which is dangerous.
- When not using the electric chain hoist, raise it to a position where the bottom hook does not reach a person's head.
 - ※ If the bottom hook is at a low position, a danger of an unexpected collision will arise.

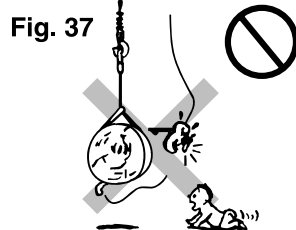

3. Operating Time

CAUTION







- Never use the electric chain hoist past its short-time rating, duty factor or starting frequency. 
- The β type is a small and lightweight electric chain hoist which is convenient for carrying around. However, it is not suitable for applications in which a chain hoist is used frequently. Regarding the operating hours, read the following, and use the chain hoist correctly.

Table 4

	Single phase	Average daily operating time (Hr)						
Short-time rating (minutes)	25 minutes (Note 1)	Load classification	~0.12	~0.25	~0.5	~1	~2	
Duty factor (%ED)	30% (Note 1)	Light						Normally used at about 1/3 of the load, and very occasionally used at the rated load.
Max frequency of start of use (Times-h)	180 times	Medium						Normally used at between 1/3 and 1/2 of the load, and occasionally used at the rated load.
		Heavy						Normally used at 2/3 or more of the load, and often used at the rated load.
		Very heavy						Almost always used at the rated load or a load near this.

Use a β type in the  area.
 Use a α type in the  area.

- The life of the product is greatly affected by the load and the operating time.
- To enable the product to be used for a long time, it is recommended that you use it within the  area.
- Contact your local dealer or our sales department in the following cases.
 - 1) If it is assumed that the product will be used over a range that exceeds the  area
 - ※ It is necessary to take adequate preventive measures such as by frequently carrying out periodic voluntary inspections.
 - 2) If it is assumed that the product will be used over a range that greatly exceeds the  area
 - ※ An α type electric chain hoist or one that is one rank higher must be selected.
 - 3) If it is assumed that the product will be used mainly over a short period
 - ※ The motor is liable to overheat or burn out, and also the load setting for the friction clutch may fall.

Note 1 : The short-time rating and the duty factor have been measured using the following method stipulated by the relevant Japan Industrial Standard (JIS).

- Short-time rating: Indicates the time during which the product can operate according to the following cycle, based on the rated load.

Hoist 1m → Rest 3sec → Lower 1m → Rest 3sec

- Intermittent rating: Indicates the time during which the product can continuous operate according to the following cycle, based on 63% of the rated load.

30%ED Hoist 6sec → Rest 14sec → Lower 6sec → Rest 14sec



The operation time occupies 30% (12 sec) during a 40-sec cycle.

4. Other Precautions

WARNING

- Never modify this electric chain hoist according to the purpose of use. 

CAUTION

- Do not use the electric chain hoist in such a way that it is exposed to rain or water.
 - ※ This will result in excessive rust and deterioration of the electrical insulation.
 - ※ In order to extend the life of the electric chain hoist when it is installed outdoors, provide an evacuation place that completely covers the body of the chain hoist.
- Be sure to carry out a daily inspection or a periodic voluntary inspection.

Fig. 38

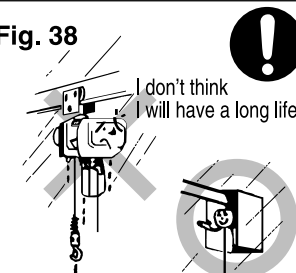



Table 5

Inspection point	Inspection item	 WARNING Inspection standard (If any of the following defects are found, replace or dispose of the defective part.)
1. Chain	1) Elongated pitch	Abnormal elongation is not allowed.
	2) Wear	Marked reduction of the wire diameter due to wear is not allowed.
	3) Deformation	Deformation is not allowed.
	4) Damage or other harmful defects	Cracks or other harmful defects are not allowed.
	5) Corrosion	Noticeable rusting is not allowed.
2. Hook	1) Opening of the hook	Marked deformation is not allowed.
	2) Deformation	Bending or twisting is not allowed.
	3) Damage or other harmful defects	Cracks or other harmful defects are not allowed.
	4) Operation	The bottom hook must rotate smoothly.
3. Body of unit	1) Each nut, bolt, screw, split pin, etc.	Nuts, bolts, screws, and split pins that are visible from outside must not be missing or loose.
	2) Oiling and grease-up	Check whether or not lubricants have been topped up, applied with a brush, or supplied to the specified points.
4. Trolley	1) Each nut, bolt, screw, split pin, etc.	Nuts, bolts, screws, and split pins that are visible from outside must not be missing or loose.
	2) Oiling and grease-up	Check whether or not lubricants have been topped up, applied with a brush, or supplied to the specified points.
5. Pushbutton switches, cords	1) Appearance	Deformation, breakage, loose screws, or other defects are not allowed. The indication must be clear.
	2) Switch operation	Switches must function correctly. Interlocks must function correctly.
6. Sling	1) Wear, deformation, or other defect	Abnormalities are not allowed.

2. No-load Operation Check

- 1) Does the bottom hook rotate smoothly? Does the safety latch function properly?
- 2) Is there any flattening or deformation of the buffer on the load side?
- 3) Has the oil been used up along the entire length of the chain? Is the chain twisted?
- 4) Is there any flattening or deformation of the buffer on the no-load side?
- 5) Has dirt or water accumulated in the chain bucket? Is the mounting condition of the chain bucket satisfactory?
- 6) Is there any foreign matter on the track along which the wheel of the trolley or the crane saddle travels?
- 7) When a pushbutton switch of the electric chain hoist is pressed, does the chain hoist move according to the indication on the switch? Do the upper and lower over-winding prevention devices operate normally? (Operate the chain hoist to the upper and lower limits several times under a no-load condition, and check to see if the over-winding prevention devices operate.)

Fig. 41

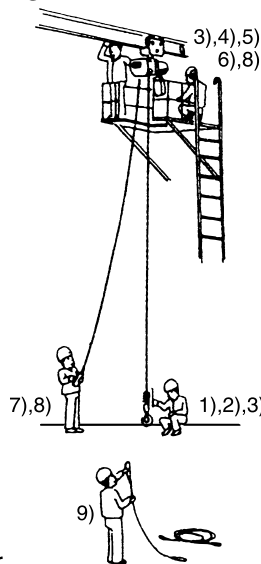

- 8) Does the electric chain hoist stop as soon as you release the pushbutton? Is any unusual noise or odor emitted? Also, confirm that the chain is wound up without problem.
- 9) Check all of the slings to be used for the day's work to ensure that there are no defects.

3. Rated Load Operation Check

Suspend the rated load, then lower it and stop it midway. Check the distance through which the load traveled from when you pressed the Stop switch until the load stopped.

- The distance to stopping should be within 1 link.

VIII) PERIODIC VOLUNTARY INSPECTIONS

Make it a rule to conduct a periodical voluntary inspection to ensure safe and full-functioned operation of the electric chain hoist.

- If as a result of performing a voluntary inspection, you replaced parts and/or carried out adjustments, check the item "Post-installation Checks, and Trial Operation" (Page 8) before re-using the electric chain hoist.
- Before carrying out an inspection, be sure to cut off the power supplied to the electric chain hoist, confirm safety in the vicinity, and then carry out the inspection.
- ※ Be sure to erect an INSPECTION IN PROGRESS sign before carrying out inspection work.
- It is recommended that you fabricate a dedicated inspection base.

1. Monthly Voluntary Inspection

- Carry out a voluntary inspection at least once a month.
 - If you discover a faulty part, carry out appropriate action.
- In the monthly voluntary inspection, place more importance on the following items.
- 1) Do all of the important functions of the electric chain hoist operate normally?
 - 2) Have any important parts deteriorated past the specified limit?
 - 3) Is power supplied to the entire chain hoist satisfactorily? Another important item is checking each clamping nut and bolt of the supporting structure and electric chain hoist for looseness.
- Concerning the inspection of the electric check hoist and the checking of the electric power supply situation, check all of the items set out in the monthly inspection sheet.
- Concerning the inspection of the supporting structure, check the necessary items separately for each crane before the inspection.
- For details of the inspection method, refer to "Method of Maintenance and Inspection" (Page 15).

2. Yearly Voluntary Inspection

If you find a fault as a result of carrying out an inspection, take appropriate remedy. Suspend the rated load, carry out a trial run of the crane, and check the various operations of the electric chain hoist and also confirm that there are no abnormalities in any part of the supporting structure.

Make the instruction manual for the inspection and carry out the inspection and maintenance in accordance with it. As for the inspection methods and measures, refer to “**the Method of Maintenance and Inspection**”(at right).

Carry out the monthly inspections at intervals of no more than one month, and carry out the yearly inspections at intervals of no more than one year.

Do not omit a monthly inspection even if it falls on the same month as the yearly inspection.

3. Usable Limit of Parts

WARNING

- Do not use parts or an electric chain hoist that has exceeded its usable limit.
If you find a worn part that has exceeded its usable limit standard as a result of carrying out a monthly or yearly voluntary inspection or another inspection, be sure to replace that part.
※It is extremely dangerous to use a part that has exceeded its usable limit standard.



- The method of checking the usable limit is set out in “**Method of Maintenance and Inspection**” and also the inspection standards and standards for use (Page 15 to 22).

IX) METHOD OF MAINTENANCE AND INSPECTION

WARNING

- Before carrying out maintenance, inspection or repair, be sure to switch OFF the power.
- Have maintenance, inspection or repair carried out by a person with specialized knowledge. Alternatively, request us to carry out this work.
- When carrying out maintenance, inspection or repair, be sure that the chain hoist is in a no-load condition (i.e. there is no suspended load).
- Do not use a part that is found to be defective as a result of carrying out maintenance and inspection.



1. Before Carrying Out an Inspection

Be sure to inspect the electric chain hoist using the correct method, to ensure that it is used safely and also exhibits its full functions.

- Before carrying out an inspection, be sure to switch OFF the power to the electric chain hoist and also ensure that it is safe in the vicinity.
- Before disassembling the electric chain hoist, be sure to lower it to the ground.
- Never replace any part with a part not specified by Elephant.

2. Hook Inspection and Usable limit

Top hook and upper attachment ring

- Is the safety latch free from defects, and does it function normally?
- Was any noticeable damage or deformation of the hook or other parts found as a result of a visual inspection?
- Are any mounting nuts, bolts or split pins slack or missing?

Hook block

- Is the safety latch free from defects, and does it function normally?
- Does the hook rotate easily and smoothly?
- Was any noticeable damage or deformation of the hook or other parts found as a result of a visual inspection?
- Are any mounting nuts, bolts or split pins slack or missing?
- In the case of an electric chain hoist that has at least two load chains, does the idle pulley rotate smoothly? Also, does it engage satisfactorily with the load chain?
- Is there a lot of foreign matter adhering to the hook block?

Measurement of hook opening

If you apply a load that is much greater than the rated load to the hook, or apply a large load to the tip of the hook, the opening of the hook will widen.

A hook with a widened opening has lost its intrinsic strength and ability to absorb impact, so replace it with a new one.

Fig. 42

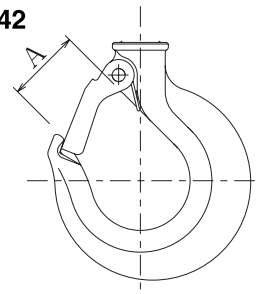

If the dimension of A in Fig. 42 exceeds the limit value in Table 6, replace the hook with a new one. It is very dangerous to attempt to repair a widened hook gap by heating the hook. Be sure to discard such a hook and replace with a new one.

Table 6 Hook replacement standard

Rated load (kg)	Dimension A (mm)	
	Standard value	Limit dimension
125 kg~200 kg	24±1	26

Damage, worn or bent hook

If a hook becomes as shown in one of 1) to 3) of Fig. 43, replace it.

Fig. 43

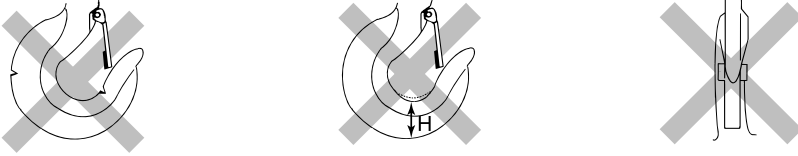

1) Sharp nicks are visible.

2) Wear: As per Table 7

3) Bending can be seen.

Table 7

Rated load (kg)	Dimension H of new hook	Limit dimension
125 kg~200 kg	16	14.4

Bottom hook

Fig. 44

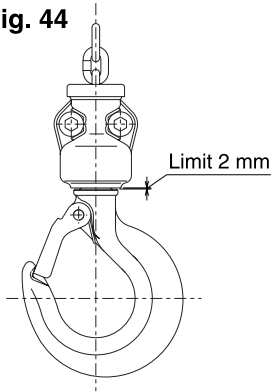
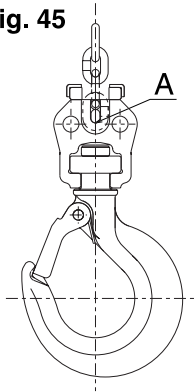

Fig. 45



If the hook does not rotate smoothly, or if the gap shown in Fig. 44 exceeds 2 mm, replace the bottom hook block.

If the deformation of the part of the hook indicated by arrow A in Fig. 45 is visible, replace the hook with a new one.

3. Chain Inspection and Usable Limit

- Has the oil been used up along the entire length of the chain?
- Is the chain markedly damaged?
- Is the chain bundled or twisted?

Fig. 46

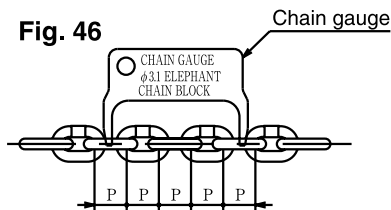

Fig. 47

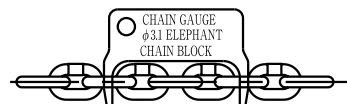
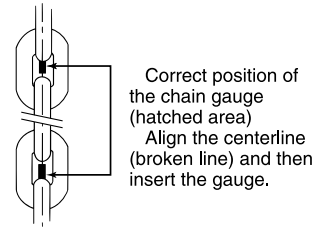

Fig. 48



Correct position of the chain gauge (hatched area)
Align the centerline (broken line) and then insert the gauge.

Measurement of pitch elongation using a chain gauge

Inspect the load chain carefully along its entire length. Do not check only part of it.

Insert the chain gauge at intervals of about 50 cm (see Fig. 48), and check the elongation of the pitch.

If the elongation of the pitch is within the usable limit, the insertion position of the chain gauge will strike the load chain, as shown in Fig. 46, preventing it from passing through the chain links.

When the pitch exceeds the usable limit, the chain gauge will pass through the chain links, as shown in Fig. 47.

If part of a chain has a pitch that is very near the usable limit, reduce the measurement interval in the vicinity of that part, and check to see if there is even one part where the chain gauge passes through the chain links.

If there is even one part where gauge passes through the chain links, replace the load chain with a new one.

Measuring the reduction of wire diameter using vernier calipers

It is dangerous to use a load chain whose wire diameter has decreased to the wear limit shown in Fig. 49, so replace the chain with a new one.

Fig. 49

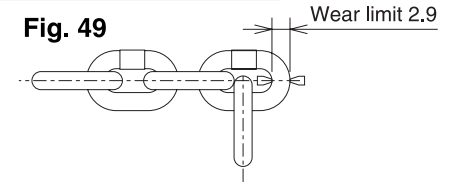

Visual inspection of the load chain

If the load chain is found to be damaged or bent, or if foreign matter is adhering to it, replace it with a new one. Discard a load chain if it has worn to the wear limit of Fig. 49, even under the most disadvantageous measurement conditions.

In addition, if the chain has clearly visible signs of shape deformation or the effect of heat, replace it with a new one.

Table 8 Correct Wire Diameter and Pitch (Unit: mm)

Rated load (kg)	Nominal diameter	Correct wire diameter	Correct pitch
125 kg~200 kg	3	3.1	9.3

Precautions for replacing the load chain

Fig. 50

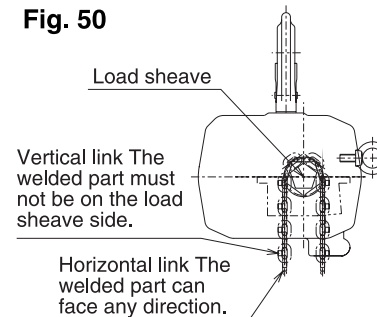

- Basically the chain should not be replaced by the customer himself. Please contact your local dealer or our sales department to have the chain replaced.
- When replacing the load chain, be careful of the following points.
- Be sure that the welded part on the vertical link is on the outer side of the load sheave. (Fig. 50)
- Replace the entire chain. Never attempt to replace only a part of it.

4. Buffer Inspection and Usable Limit (Both the load side and the no-load side)

- The urethane buffer must not flatten or become cracked
- The buffer case must not be out of place.

5. Chain Bucket Inspection and Usable Limit

If one of the following conditions was found, replace the chain bucket. Do not continue to use it in this condition.

- When the chain bucket is damaged.
 - ※ There is a danger of the load chain dropping.
- When one of the parts used to suspend the chain bucket is not installed correctly.
- When dirt or water has accumulated inside the chain bucket.

6. Chain Stopper Inspection

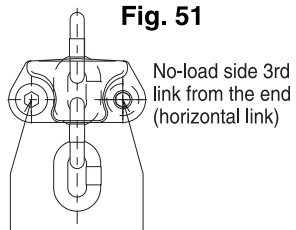

Fig. 51

Check the following condition. If the chain stopper is broken, replace it. Do not continue to use it if it is broken.

- Carry out a monthly inspection to see if the hex socket head bolts of the chain stopper are loose.

The chain stopper on the no-load side must be mounted on the third link (horizontal link, See Fig. 50) counting from the no-load side end of the load chain. (Fig. 51)

Adequately tighten using a wrench.

7. Pushbutton Switch Inspection

Check the following condition. If there is a fault, replace the pushbutton switch unit. Do not continue to use it in a defective condition.

- If the case is cracked
- If the pushbuttons do not operate smoothly (If the pushbuttons do not return smoothly when they are released)
 - ※ If you remove the cover and find loose screws or defective lead wires.
- If a lot of foreign matter is stuck to the pushbutton switches

8. Trolley Inspection and Usable Limit

Check the following condition.

Bent side plate

Fig. 52

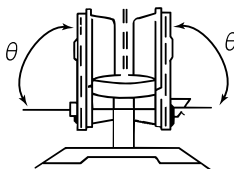

- Bending of the two side plates is not allowed.
- The angle θ in the drawing must be a right angle.
- During a traverse operation, if a strange noise is emitted due to lack of oil, replenish the oil.
- Missing or loose nuts and bolts are not allowed.
- Accumulation of dirt on the teeth of a wheel in which teeth have been cut is not allowed.

Wear of the trolley wheel

Replace the trolley wheel if it is in one of the following conditions.

Fig. 53

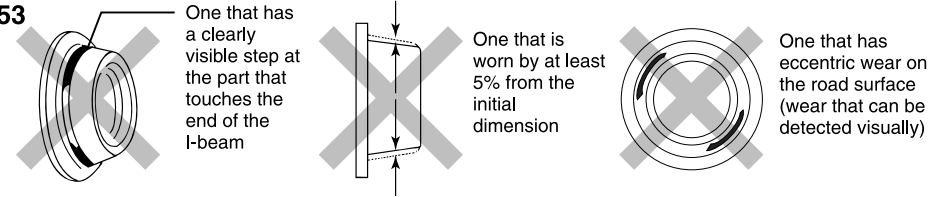

9. Motor Brush Inspection and Usable Limit

For safety's sake, when checking the motor brushes, be sure to carry out the following work.

- 1) Put the electric chain hoist in a no-load condition.
- 2) Switch OFF the power.



CAUTION

- If the brushes in the motor become markedly worn, causing the speed of the motor to fluctuate or an unusual noise to be emitted, replace the brushes.

If you replace the brushes, get carbon power out of the motor in manner of Fig.54. Put on eye protector and mask not to inhale carbon powder and to prevent carbon powder from entering the eye.

- ※ The motor uses 11 mm brushes. If they are found to be 6 mm or less during a periodic inspection, replace them.

As the brush wear increases, the motor is increasingly liable to become damaged or cease to rotate.

Fig. 54 Air gun etc.

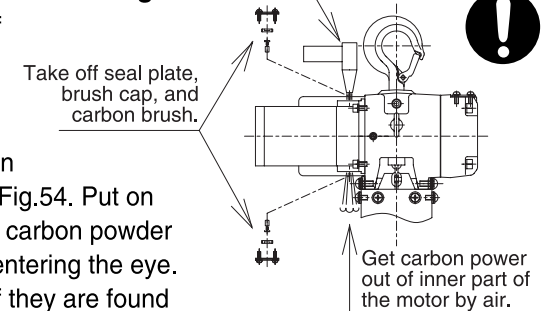
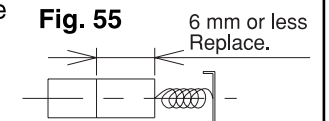

Fig. 55



10. Nameplate and Tag Inspection

- Do not remove the nameplate, warning labels or the tag.
- Are the indications on the nameplate and the tag easy to read? Do not allow dirt to accumulate on the nameplate and the tag. Keep them clean at all times.
- The following three items are important when ordering parts. Please make a note of them, and when ordering parts be sure to indicate these items together with the part names and part Nos. (or assembly No.) in the schematic diagram.

- 1) Model No.
- 2) Rated load
- 3) Manufacturing No. (SERIAL No.)

11. Gear Oil Inspection

(1) Oil change (See Fig. 56.)

When changing the oil, remove the body of the chain hoist from the sling, then remove the oil cap for changing the oil from the top of the gear case, and invert the body to drain off the oil inside.

Next, attach the body of the chain hoist to a sling, hold the gear case in a horizontal condition, and pour in exactly the correct amount of oil (reference quantity indicated in Table 10).

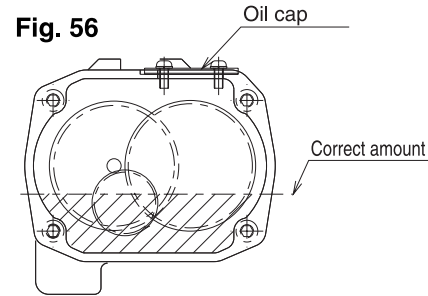

During the period from when you start using the chain hoist for the first time until the chain hoist is run in, dirt will appear in the oil. For this reason, change all of the oil during the sixth month after you use a new chain hoist for the first time. Subsequently, so long as there is no significant deterioration of the oil, simply replenish the deficiency.

(2) Specified oil

Table 9 Kinds of Oil

Genuine oil

Showa Shell	Terrace Oil T-46
-------------	------------------

Applicable oil

Nippon Oil Corporation	Uniway 46
General Sekiyu K.K.	Slidol 46
ESSO	Febis 46
Cosmo Oil Co., Ltd.	Cosmo Mighty 46
Idemitsu Kosan	Multiway 46
	Super Multi 46
Mobil	Way Oil 46

(3) List of oiling points

Table 10 Oiling Points

Oiling point	Gear case	Load chain
Kinds of lubricating oil	Lubricating oil for sliding surfaces	Oil
Oiling method	Oil bath	Coating with a brush
Name of oil	Showa Shell	Showa Shell
	Terrace Oil T-46	Terrace Oil T-46
Reference quantity	0.15 l	10 cc/m
Oil change frequency	1 year	-
Oil change quantity	0.15 l	-
Oil replenishment period	6 months	Before use
Oil replenishing quantity	Suitable quantity	Suitable quantity

12. Wiring the Inside of the Electric Chain Hoist and Tightening the Various Parts

Check the internal wiring for damage and also check for loose terminals and connectors. Also, check each clamping bolt for looseness.

※ If there are any loose bolts, tighten them.

13. Overall Operation Check and Usable Limit

After completion of the inspection of each part, carry out a trial run according to "Post-installation Checks, and Trial Operation." (Page 8)

- Does the unit move in the direction corresponding to the pushbutton that you pressed?
- Release the pushbutton, and check the distance from the position of the hook at that point in time to the position where the hook stops.
- Do the upper and lower limit over-winding prevention devices function normally?
- Is an unusual noise generated when the chain hoist is moving up and down, traversing or traveling?

X) TROUBLESHOOTING AND REMEDY

The table below lists the main causes of trouble in a general electric chain hoist. If trouble other than that listed in the table occurs, please contact your local dealer or our sales department.

Table 11 Fault Diagnosis Table

Fault or breakdown	Main cause	Remedy	Remarks
1. Motor does not rotate	● The switch on the distribution panel is not ON. Blown fuse, tripped breaker	Check the distribution panel, and take the necessary action to supply power from the panel.	
	● Wrong power supply	Use the correct power supply indicated on the nameplate.	
	● Very large voltage drop	Obtain the specified supply voltage. Use the correct power supply cord.	If the power cord is too thin, the voltage may drop abruptly when the motor starts.
	● Very large overload	Use a load of no more than the rated value.	
	● Burnt-out motor	Replace the motor.	
	● Worn motor brushes (Refer to 9 "Motor Brush Inspection and Usable Limit" in "Method of Maintenance and Inspection.")	Replace the brushes.	
● Rectifier is broken.	Replace the rectifier.		

2. Motion of chain hoist differs from the indication on the pushbutton.	<ul style="list-style-type: none"> Incorrect wiring of pushbutton, etc., in the unit 	Connect the wiring correctly according to the connection diagram.	
	<ul style="list-style-type: none"> The motor connections are wrong. 	Change over the connections to the terminals.	
3. Load is not hoisted.	<ul style="list-style-type: none"> Very large overload 	Use a load of no more than the specified value.	
	<ul style="list-style-type: none"> Lining of the over-winding prevention devices is worn. 	Adjust the over-winding prevention devices. (Contact your local dealer or our sales department.)	
	<ul style="list-style-type: none"> Pushbutton, rectifier or internal wiring is loose. 	Check the continuity, and replace any damaged parts. Check the connections.	
4. Load is not lowered.	<ul style="list-style-type: none"> Pushbutton, rectifier or internal wiring is loose. 	Check the continuity, and replace any damaged parts. Check the connections.	
5. The brake does not function.	<ul style="list-style-type: none"> The cement resistor is broken. 	Replace the cement resistor.	
6. Brake does not operate immediately.	<ul style="list-style-type: none"> The contacts of a pushbutton are damaged. 	Replace the pushbutton switch unit.	
	<ul style="list-style-type: none"> The contacts inside the motor are worn. (200 V) 	Replace the motor.	
7. Large inertia when the hoisting and lowering operations are stopped.	<ul style="list-style-type: none"> The motor brake lining is worn. 	Adjust the motor brake (Contact your local dealer or our sales department.)	
	<ul style="list-style-type: none"> The unit is overloaded. 	Use a load of no more than the rated value.	
8. Speed is slow.	<ul style="list-style-type: none"> The unit is overloaded. 	Use a load of no more than the rated value.	
	<ul style="list-style-type: none"> The power supply voltage is low. 	Obtain the specified voltage.	
		The power cord is too thin.	
9. Motor is abnormally hot.	<ul style="list-style-type: none"> The unit is overloaded. 	Use a load of no more than the rated value.	
	<ul style="list-style-type: none"> The power supply voltage is low. 	Obtain the specified voltage.	
		If the power cord is too thin, replace it with a thicker one.	

	<ul style="list-style-type: none"> The outdoor temperature is very high. 	Avoid radiant heat, and maintain the ambient temperature at no more than 40°C.	
	<ul style="list-style-type: none"> The short-term ratings and intermittent ratings are exceeded. 	Operate the unit within the ratings.	
10. Noise level is higher than normal.	<ul style="list-style-type: none"> The gears are excessively worn. 	Replace the worn parts.	
	<ul style="list-style-type: none"> Chain, load sheave, or chain guide is excessively worn. 	Replace the worn part.	
	<ul style="list-style-type: none"> Insufficient lubricating oil 	Supply the specified oil by referring to the "Machine model manual."	
11. Wear of the chain is faster than that of other electric chain hoists.	<ul style="list-style-type: none"> Insufficient or no lubricating oil 	Supply the specified oil.	
	<ul style="list-style-type: none"> The load sheave or chain guide is worn. 	Replace the worn part with a new one.	
	<ul style="list-style-type: none"> The unit is overloaded. 	Use a load of no more than the rated value.	
12. The chain does not engage well with the load sheave.	<ul style="list-style-type: none"> The chain used is unsuitable. 	Replace with the correct chain.	If the chain is worn and must be replaced with a new one, check the wear condition of the load sheave and the chain guide as well.
	<ul style="list-style-type: none"> Chain, load sheave, or chain guide is excessively worn. 	Replace the worn part with a new one.	
13. The user receives an electric shock when he touches the electric chain hoist.	<ul style="list-style-type: none"> The unit is not grounded. 	Securely connect a grounding wire to the unit.	
	<ul style="list-style-type: none"> Insulation defect has occurred in an electrical part such as the pushbutton switch unit. 	Repair or replace the defect part.	
14. Oil leakage	<ul style="list-style-type: none"> Loose gear case fixing bolt 	Tighten the fixing bolt.	
	<ul style="list-style-type: none"> Damage to the packing or oil seal 	Replace with a new part.	



XI) STANDARDS COVERING USE AND INSPECTION (JIS)

The following criteria are prepared with reference to “the Safety Rules for Chain Hoists(JIS B8815) , Cranes and the Like” Strictly observe them in using the electric chain hoist.

Table 14

WARNING(1. Criteria for use)



The following shall be observed in using the electric chain hoist.

- (1) Make sure that the type, class and range of lift of the electric chain hoist, etc. are fit for conditions of its use. 
- (2) The electric chain hoist should be used only at the rated voltage and frequency. Consult us in case that a power generator is used directly as power source.
- (3) The electric chain hoist should be used under its perfectly grounded condition to avoid electric shock.
- (4) The electric chain hoist should be daily checked before use, and be inspected periodically at given intervals.
- (5) The electric chain hoist should not be modified without our approval. If any modification is necessary, it should be done by us.
- (6) The electric chain hoist should be hung on beams and the like having sufficient strength. In the case of trolley type hoists, they should be hung on traverse rails (for example, H-shaped or I-shaped steels) having sufficient and accuracy.
- (7) Before using the electric chain hoist, check whether or not the load chain is passed in a loop around the sheave wheel with the bottom hook, or twisted or kinked, and use after correcting these irregular forms.
- (8) Use load chains lubricated.
- (9) When the electric chain hoist is used in special conditions such as lower or higher temperatures, or corrosive atmosphere, etc. , consult us before use.
- (10) Use the electric chain hoist, applying lubricants at appropriate intervals to its gears, bearings and points which are liable to wear.
- (11) When the electric chain hoist is used outdoors, provide a cover to prevent water and rain.
- (12) Load chains other than those specified by us should not be mounted to the electric chain hoist. 

- (13) The electric chain hoist should not be used with loads higher than the rated load, and not be used under such conditions as giving impulsive force to it.
- (14) In inverse turn from lifting to lowering and vice versa, etc. , stop once movement and then carry out next operation. Plugging operation (sudden reverse turn) should be avoided.
- (15) Avoid such an operation as to often use the over-lifting/lowering protection device.
- (16) Avoid to pull a load in oblique direction.
- (17) Avoid an operation to heavily swing a load.
- (18) Don't pull the push-button switch cord to traverse a load suspended (horizontal pulling) .
- (19) Don't fall the electric chain hoist from higher positions.
- (20) Don't make electric welding of a load in suspension by the electric chain hoist.
- (21) Avoid frequent inching operation.
- (22) Avoid such an operation as to apply a sudden force to load chains.
- (23) Don't wind load chains directly around a load.
- (24) Don't hang a load on the tip of the hook.
- (25) Avoid an operation of so-called earth lifting.
- (26) Don't leave the electric chain hoist for many hours with a load suspended.
- (27) Pay attention that any persons or their hands or legs are not right underneath a load suspended.

CAUTION (1. Criteria for checking)

The following shall be observed in using the electric chain hoist.

- (1) In case of 3 phase induction motor, it should not be operated in single phase. 
- (2) Don't press the emergency stop button in a normal condition (option) .
- (3) When the electric chain hoist is installed for the first time, make sure that the power lines are not connected in the reverse phase. 
- (4) To avoid a voltage drop of the electric chain hoist, it is recommendable to use power cables with bigger size.
- (5) When the electric chain hoist will not be used for a long time, turn off the power source and keep it after rust preventive treatment in places where it is not subject to rain water and sea breeze.
- (6) When the electric chain hoist is used with cranes, as simplified lifting devices, or in ships, mines or petrochemical plants, especial care should be taken to relevant laws and regulations.

2. Criteria for check

- (1) Use the electric chain hoist by checking it daily 1) and periodically 2) .
- (2) Refer to Table 15 3) which gives check items, check methods and check criteria to be used in the daily check. However, items other than those specified should be also checked, when the electric chain hoist is frequently used, or in special cases.
- (3) Repair or replacement of parts should be carried out by those persons who are familiar with the function of the electric chain hoist, or ask a dealer of our products.
- (4) When the electric chain hoist is repaired, check it on periodic check items given in Table 15 after its repair, and make sure that it works in a normal state.
- (5) Don't use the electric chain hoist which has reached the limits of total allowable running hours.

Notes 1) Refer to checking before use.

2) Periodic check is usually made at intervals of one month, three months, six months or one year depending on the frequency of use, and consult us about the periodic check which can be also made in our factory.

3) Check the items with the mark "O" in Table 15.

Remark:

When a hoist is considered to be capable of being further use, while it has already reached the limits of allowable running hours, it may be used, having deliberated on its use with us.

Table 15 Criteria for check

Type of check		Check items	Check method	⚠ WARNING ! Check criteria (devices and parts out of the following criteria should be replaced or disposed as waste.)
Dail check	Periodic check			
<input type="radio"/>	<input type="radio"/>	Marking (nameplates, labels)	Visual	Presence of marking. Replace them if unreadable.
Load chain				
	<input type="radio"/>	Type	Visual	Confirm the type of load chain
<input type="radio"/>	<input type="radio"/>	Pitch elongation	Check visually in daily check and by measurement in periodic check.	Don't use load chains with pitch elongation of 3% minimum (Prepare a list of standard dimensions before use.)
<input type="radio"/>	<input type="radio"/>	Wear	Check visually in daily check and by measurement in periodic check.	Don't use load chains which are worn in diameter by 5% or more.
<input type="radio"/>	<input type="radio"/>	Deformation	Visual	Free from deformation.
<input type="radio"/>	<input type="radio"/>	Flaws and other harmful defects	Visual	Free from cracks and other harmful defects
<input type="radio"/>	<input type="radio"/>	Corrosion	Visual	Free from serious rust.
Hooks				

<input type="radio"/>	<input type="radio"/>	Opening of hook	Check visually in daily check and by measurement in periodic check.	No deformation should be found when its dimensions are compared with standard dimensions (A list of major dimensions of hooks should be prepared before their use.)
<input type="radio"/>	<input type="radio"/>	Deformation	Visual	Free from bend and distortion.
<input type="radio"/>	<input type="radio"/>	Latch	Visual	Free from severe wear or deformation and operates properly.
<input type="radio"/>	<input type="radio"/>	Deformation of shank	Check visually in daily check and by measurement in periodic check.	There should be no big clearance between hook and shank.
<input type="radio"/>	<input type="radio"/>	Swiveling	Visual	It can swivel smoothly and horizontally through 360 degrees.
<input type="radio"/>	<input type="radio"/>	Wear and corrosion	Visual	Free from severe wear and corrosion.
<input type="radio"/>	<input type="radio"/>	Flaws and other harmful defects	Visual(4)	Free from cracks and other harmful defects
Body				
<input type="radio"/>	<input type="radio"/>	Frame	Visual	Free from deformation and severe corrosion.
<input type="radio"/>	<input type="radio"/>	Gear case	Visual	Free from severe deformation and corrosion.
<input type="radio"/>	<input type="radio"/>	Nuts, revets, split pins, snap rings, etc. at all the components	Visual	In daily check, the presence of nuts, revets, split pins, etc. which can be seen from outside should be checked, and nuts, rivets, snap rings, etc. should not get loose. In periodic check, abnormality of the said parts should be checked internally and externally
	<input type="radio"/>	Gears	After dismantling check them visually or by measurement.	Free from abnormal noise, wear and breakage.
	<input type="radio"/>	Load sheave and idle sheave	After dismantling check them visually or by measurement.	Free from severe wear, deformation, flaws and breakage.
	<input type="radio"/>	Chain guide	Visually or by measurement	Free from severe wear, deformation and breakage.
	<input type="radio"/>	Limit lever	Visual	Free from severe wear, deformation and breakage, and operates smoothly.
	<input type="radio"/>	Bearings	Visually or by measurement	Free from harmful defects such as wear, flaws, breakage, etc.
<input type="radio"/>	<input type="radio"/>	Lubrication and greasing up	Visually and by measurement	Lubrication to the specified points and replenishment. (Change of gear-case oil if contaminated.)
Brakes and the like				
	<input type="radio"/>	Brake linings, brake discs and brake shoes	Visually and by measurement	Free from severe wear or local wear. Free from flaws and breakage.

	<input type="radio"/>	Brake screws (in mechanical braking device)	Visually or by measurement	Free from severe wear, deformation, flaws and breakage.
	<input type="radio"/>	Ratchet and wheel (in mechanical braking device)	Visually or by measurement	Free from severe wear, deformation, flaws and breakage.
	<input type="radio"/>	Brake springs (in electro-magnetic braking device)	Visually or by measurement	Free from severe wear, deformation, flaws and breakage.
	<input type="radio"/>	Oil seals and water-proof seals	Visual	Free from severe deformation and breakage.
	<input type="radio"/>	Chain buckets	Visual	It should be securely mounted on the hoist body and free from severe wear, deformation and breakage.
Motors and the Like				
	<input type="radio"/>	Motors (3 phase or single phase) (Single phase magnet-motors)	Visually and by measurement	It should not be over-heated and be sufficiently insulated. (Brush and commutator should not be severely worn.
	<input type="radio"/>	Electrical instrument (electro-magnetic contactors, relays, transformers, wiring, etc.)	Visually and by manipulation	They should not be over-heated, be sufficiently insulated and operate smoothly. Wiring is secured, and all contacts of electrical instrument are in good order.
Traversing equipment (incl. Traveling equipment)				
	<input type="radio"/>	Traversing equipment	Visually and by measurement	There should be no abnormality in the combination of traversing equipment with the hoist body and in gears, brakes, wheels, hand chains, etc.
<input type="radio"/>	<input type="radio"/>	Nuts, rivets, split pins, snap rings, etc. in the equipment	Visual	In daily check, the presence of nuts, rivets, split pins, etc. which can be seen from outside should be checked, and nuts, rivets, snap rings, etc. should not get loose. In periodic check, abnormality of the said parts should be checked internally and externally.
<input type="radio"/>	<input type="radio"/>	Lubrication and greasing up	Visually and by measurement	Lubrication to the specified points and replenishment.
Push-button switches and Cords				
<input type="radio"/>	<input type="radio"/>	Appearance (marking, labels)	Visual	There should be no deformation, breakage, loose screws and the like. Marking should be clear and be exchanged with new one if unreadable.
<input type="radio"/>	<input type="radio"/>	Switch manipulation	By manipulation	Switches and an interlock system function properly.
Power source connection				
	<input type="radio"/>	Grounding	By measurement	Perfectly grounded

<input type="radio"/>	<input type="radio"/>	Reverse phase	By operation	Connection should not be in reverse phase.
Function and Performance				
<input type="radio"/>	<input type="radio"/>	Lifting and lowering function	Lift and lower without load (at rated voltage and rated frequency) .	Load chains should be smoothly wound or unwound in lifting and lowering operation. For hoists with mechanical braking system, sound of the ratchet should be heard in lifting operation. There should be no abnormality in the braking system in lowering operation.
<input type="radio"/>	<input type="radio"/>	Traversing function	Carry out traversing without load.	Hoists should be smoothly traversed and should stop immediately after the operation is discontinued.
	<input type="radio"/>	Starting	Visual	Hoists should be smoothly lifted, lowered or traversed at 90 % of the rated voltage.
	<input type="radio"/>	Speed	Visually and by measurement	The lifting and traversing speeds at the rated load should be within indicated values.
<input type="radio"/>	<input type="radio"/>	Braking	Check visually in daily check and by measurement in periodic check.	The brake should securely function and a fall distance, having cut off the motor, should be less than 1% of the lifting amount in one minute.
<input type="radio"/>	<input type="radio"/>	Protection against over-lifting (friction clutch)	Operate without over-load to carry out over-lifting or over-lowering.	The protection device against over-lifting should properly function. (Make sure that the friction clutch is actuated, while the motor runs at idle.)
Load				
	<input type="radio"/>	Loading	Carry out lifting, lowering or traversing at the rated load.	When hoists are operated at the rated load, rated voltage and rated frequency, there should be no abnormality in every part.
	<input type="radio"/>	Load limiter	Lifting under over-load conditions	The limiter should come to action at the preset value.
	<input type="radio"/>	Others	Visually or by measurement	There should not be any other harmful defects in use of the unit.

Note (4) : In periodic check, the magnetic particle test prescribed in JIS G 0565 or the liquid penetrant test in JIS Z 2343 should be carried out when necessary.

XII) WIRING DIAGRAM

**WIRING DIAGRAM FOR ELECTRIC CHAIN HOIST
(BS-012~BS-020)**

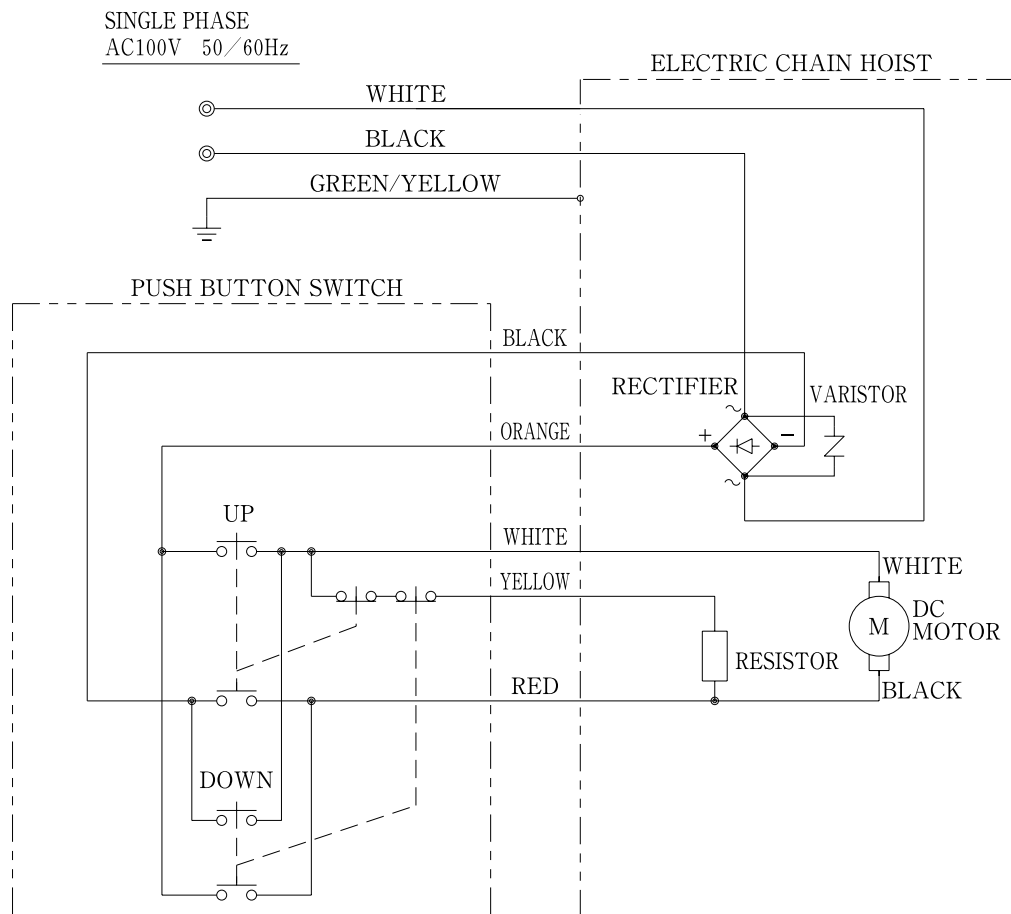

**WIRING DIAGRAM FOR ELECTRIC CHAIN HOIST
(BH-012~BH-020)**

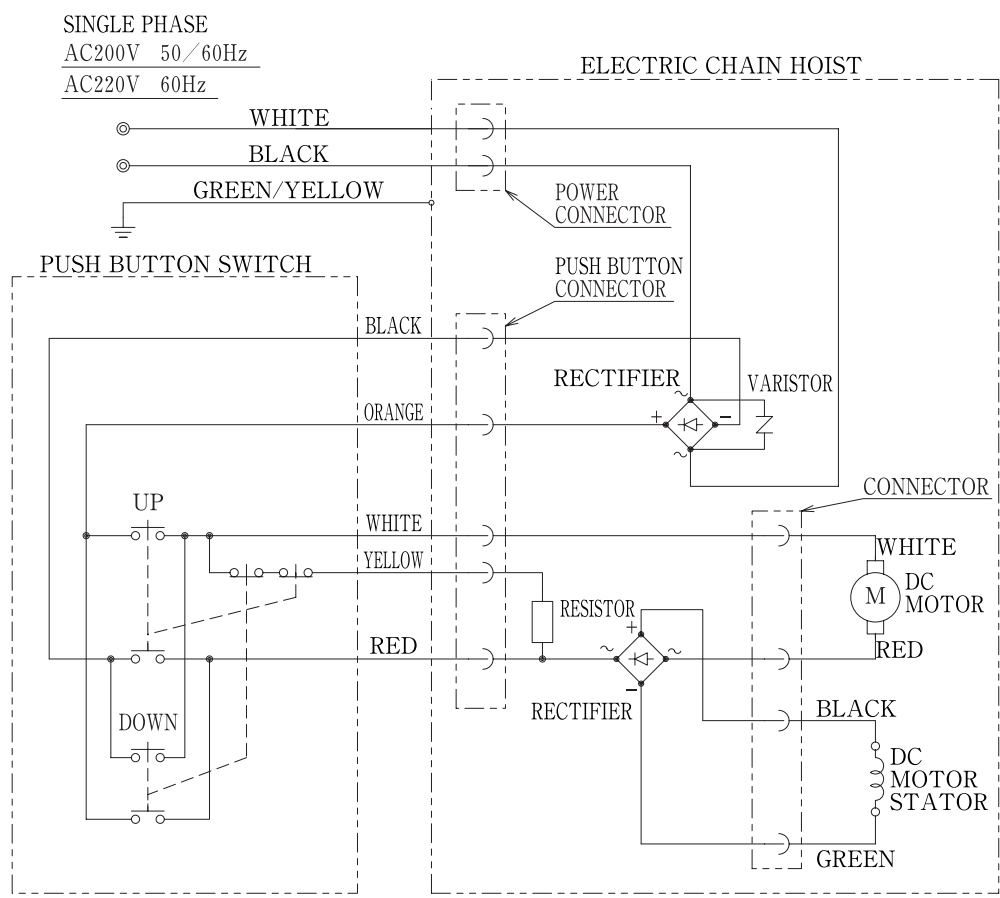

DETAIL DRAWING β TYPE

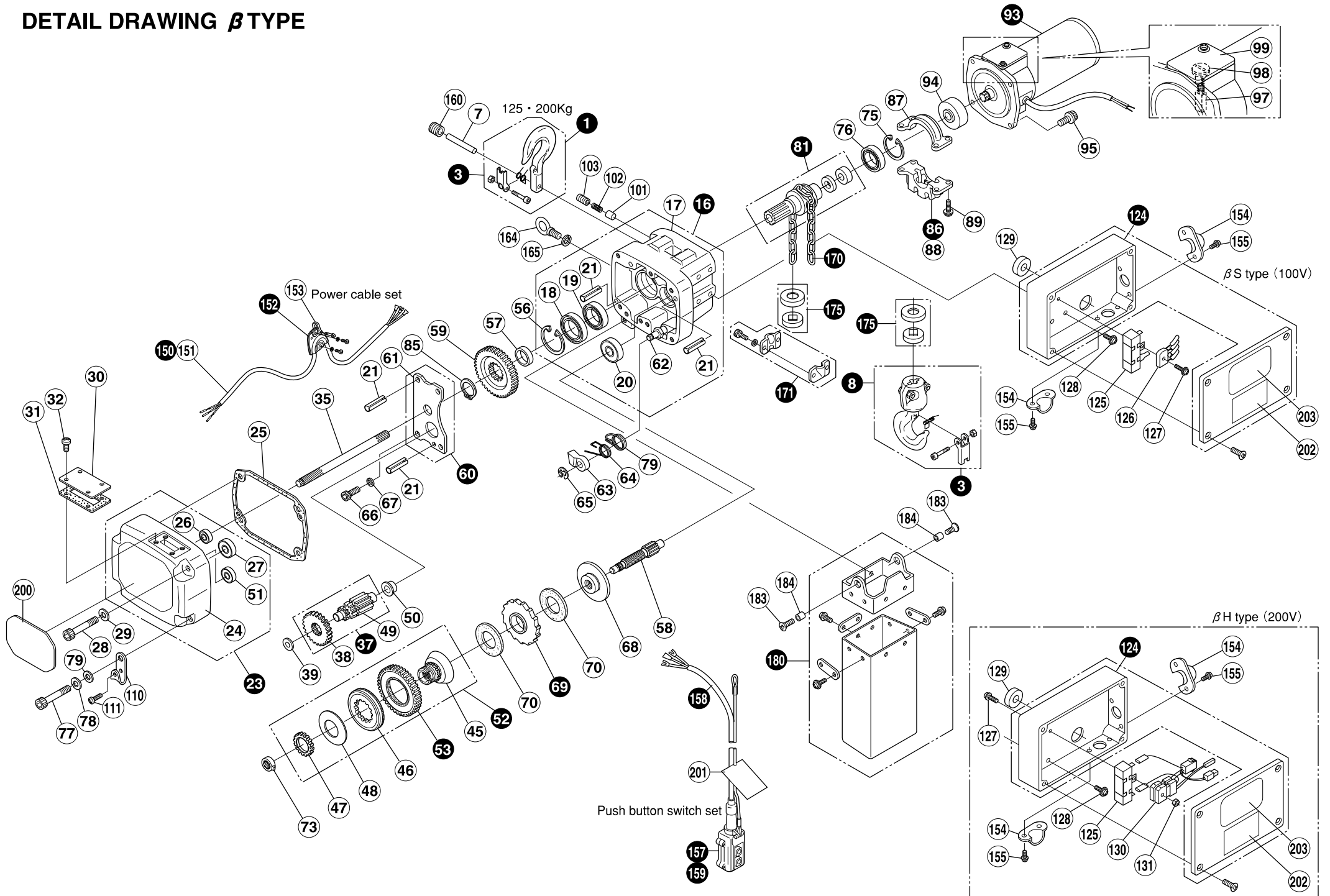

- ① Top hook ass'y
- ③ Safety latch ass'y
- ⑦ Top hook pin
- ⑧ Bottom hook ass'y
- ⑬ Main body case set
- ⑰ Main body case
- ⑱ Ball bearing
- ⑲ Oil seal
- ⑳ Ball bearing
- ㉑ Spring pin
- ㉓ Gear case ass'y
- ㉔ Gear case
- ㉕ Main body case packing
- ㉖ Ball bearing
- ㉗ Ball bearing
- ㉘ Bolt w/hex. hole
- ㉙ Spring washer
- ㉚ Oil cap
- ㉛ Oil cap packing
- ㉜ Round head screw w/cross hole
- ㉝ 1st gear
- ㉞ 2nd & 3rd gear ass'y
- ㉟ 2nd gear
- ㊱ Simring
- ㊳ Disc hub B
- ㊴ Disc hub C
- ㊵ Adjusting nut
- ㊶ Disc spring
- ㊷ 3rd gear
- ㊸ Ball bearing
- ㊹ Ball bearing
- ㊺ Friction clutch set
- ㊻ 4th gear set
- ㊼ C-clip (for hole)
- ㊽ Collar for Sixth gear
- ⑤⑧ 5th gear(125kg or 200kg)
- ⑤⑨ 6th gear(125kg or 200kg)
- ⑥⑩ Middle plate set
- ⑥① Middle plate
- ⑥② Pawl pin
- ⑥③ Pawl
- ⑥④ Pawl spring
- ⑥⑤ E ring
- ⑥⑥ Bolt w/hex. hole
- ⑥⑦ Spring washer
- ⑥⑧ Disc hub A
- ⑥⑨ Ratchet wheel set
- ⑦⑩ Brake lining
- ⑦③ Check washer
- ⑦⑤ C-clip (for hole)
- ⑦⑥ Ball bearing
- ⑦⑦ Bolt w/hex. hole
- ⑦⑧ Spring washer
- ⑦⑨ Pawl spring B
- ⑧① Load sheave set
- ⑧⑤ C-clip (for shaft)
- ⑧⑥ Chain guide set
- ⑧⑦ Chain guide (upper side)
- ⑧⑧ Chain guide (down side)
- ⑧⑨ Bolt w/hex. hole & washer
- ⑨③ Single phase motor set
- ⑨④ Motor shaft joint
- ⑨⑤ Bolt w/hex. hole & washer
- ⑨⑦ Carbon brush
- ⑨⑧ Brush cap
- ⑨⑨ Seal plate w/rubber & screw
- ⑩① Lining for motor brake
- ⑩② Spring for motor brake
- ⑩③ Hexagon socket screw
- ⑩⑩ Push button hanger fitting
- ⑩⑪ Round head screw w/cross hole
- ⑩⑭ Electric equipment case set
- ⑩⑮ Cement resistor
- ⑩⑯ Rectifier
- ⑩⑰ Round head screw w/cross hole
- ⑩⑱ Round head screw w/cross hole
- ⑩⑲ Grommet
- ⑩⑳ Harness
- ⑩㉑ Hex. nut
- ⑩㉓ Power cable set
- ⑩㉔ Power cable
- ⑩㉕ Power cord holder
- ⑩㉖ Shackle
- ⑩㉗ Cord supporter
- ⑩㉘ Hex. bolt w/cross hole
- ⑩㉙ Push button switch set
- ⑩㉚ Push button cable set
- ⑩㉛ Push button switch
- ⑩⑯① Hexagon socket screw
- ⑩⑯④ Eye bolt
- ⑩⑯⑤ Spring washer
- ⑩⑯⑦ Load chain
- ⑩⑯⑱ Chain stopper ass'y
- ⑩⑯⑳ Buffer ass'y
- ⑩⑯㉑ Chain bucket ass'y
- ⑩⑯⑳③ Round head screw w/cross hole
- ⑩⑯㉔ Collar
- ⑩⑯㉕ Name plate
- ⑩⑯㉖ Warning tag
- ⑩⑯㉗ Warning label
- ⑩⑯㉘ Type name label



ELEPHANT CHAIN BLOCK CO.,LTD.

Subject to change without notice.

(#951-147) 2013. 12. 300 (S)